

**Operating Manual**

# STA<sup>TM</sup>

Single Tooth Anesthesia System

*Featuring the STA Wand Handpiece*

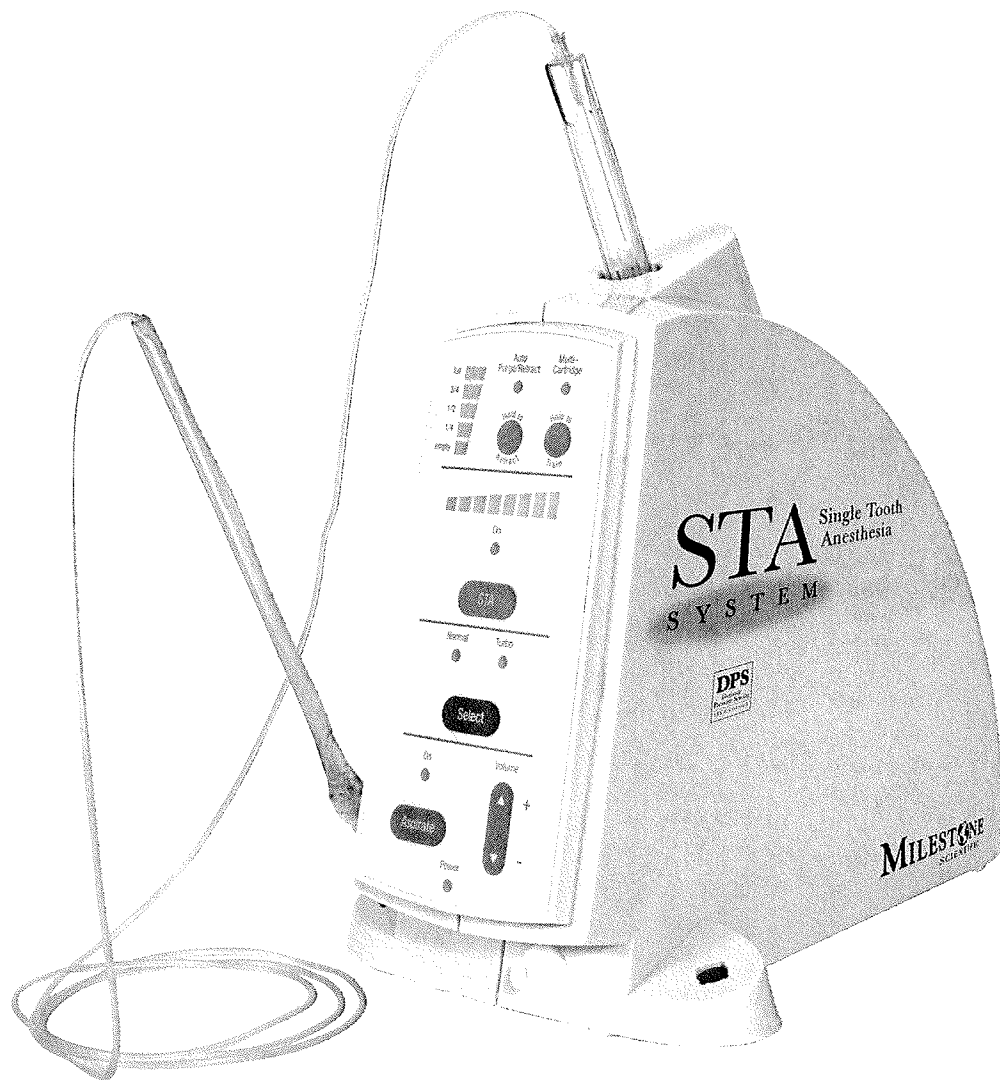

**MILESTONE**  
SCIENTIFIC

**STA-5110 110 volts**  
**STA-5220 220 volts**

**Caution: Federal law restricts this device to sale by or on the order of a dentist or physician.**

**MEDICAL USE:**

**This device is intended for use only in subcutaneous or intramuscular injections of local anesthetic agents for dental applications. It should not be used for intravascular (IV) or other routes of administration. This device should be used only by practitioners who are familiar with, and observe applicable labeling regarding the use of local anesthetic agents for dental applications.**

**The STA system senses real time relative interstitial pressures at the tip of the needle.**

**The STA system facilitates the targeting of the intraligamentary space.**

**Milestone Customer Care**

**If there are any questions or you need assistance, please call us immediately toll-free at:**

**USA Milestone Scientific  
220 South Orange Avenue  
Livingston, NJ 07039  
1-800-862-1125**

**EU PDS Ltd.  
Nottingham, UK  
NG1 1GF  
+44 (0) 115-912-4277**

# CONTENTS

## INTRODUCTION

## FEATURES

### I Basic Operation

Basic Operation	4
The STA Handpieces	4
STA <i>Wand</i> <sup>™</sup>	5
One Handed Needle Recapping Technique	6
SafetyWand <sup>™</sup>	7
Warnings and Cautions	11
Additional Important Information	12
Basic Modes of Operation	13
Foot Control Operation	14
Cruise Control Function	15
Manual Purge and AutoPurge	16
Multi-Cartridge Feature	17
Plunger Operation	18
Removal of Cartridge	18
Aspiration	19
Audible Signals	20
Cartridge Volume Gauge and Audible Cartridge Tone Indicator	20
Dynamic Pressure Sensing <sup>™</sup> Technology	21
STA-Intraligamentary Injection	21
Dosage Volume	24
Training Mode	25
Global Default Settings	26

### II Maintenance and Care

27

### III Advanced Operation

32

Dynamic Pressure Sensing (DPS <sup>™</sup> ) Technology	32
Dynamics of the injection	33

### IV Clinical Techniques

38

STA-Intraligamentary	39
AMSA	42
P-ASA	45
Traditional	47
Inferior Aveolar	48

### V Additional Information

49

Warranty Information	49
Product Safety Information	51



## INTRODUCTION

### Introduction to STA™ System featuring the STA Wand™ handpiece

Congratulations on purchasing your new **STA Single Tooth Anesthesia** computer controlled local anesthetic delivery system (CCLADS). The STA System is a state of the art device which facilitates a wide variety of anesthetic injections, including palatals and STA-Intraligamentary Injections, consistently and comfortably to your patients.

The **STA** System is the only local anesthetic delivery system that incorporates Dynamic Pressure Sensing Technology™ (DPS). DPS technology is a revolutionary technology developed by Milestone Scientific Inc. that allows dental professionals to perform successful single tooth anesthesia techniques using the STA-Intraligamentary Injection. This technique is detailed within the manual.

Please take the time to familiarize yourself with the **STA** System by reading the manual. You should also practice a few injections at the “bench” to familiarize yourself with the system.

We hope that your new STA System provides many years of successful service to you and to your patients. If you have any questions or comments, please call Milestone Scientific Inc. at 1-800-862-1125.



**Read the following contents of this manual before using the system.**

# FEATURES

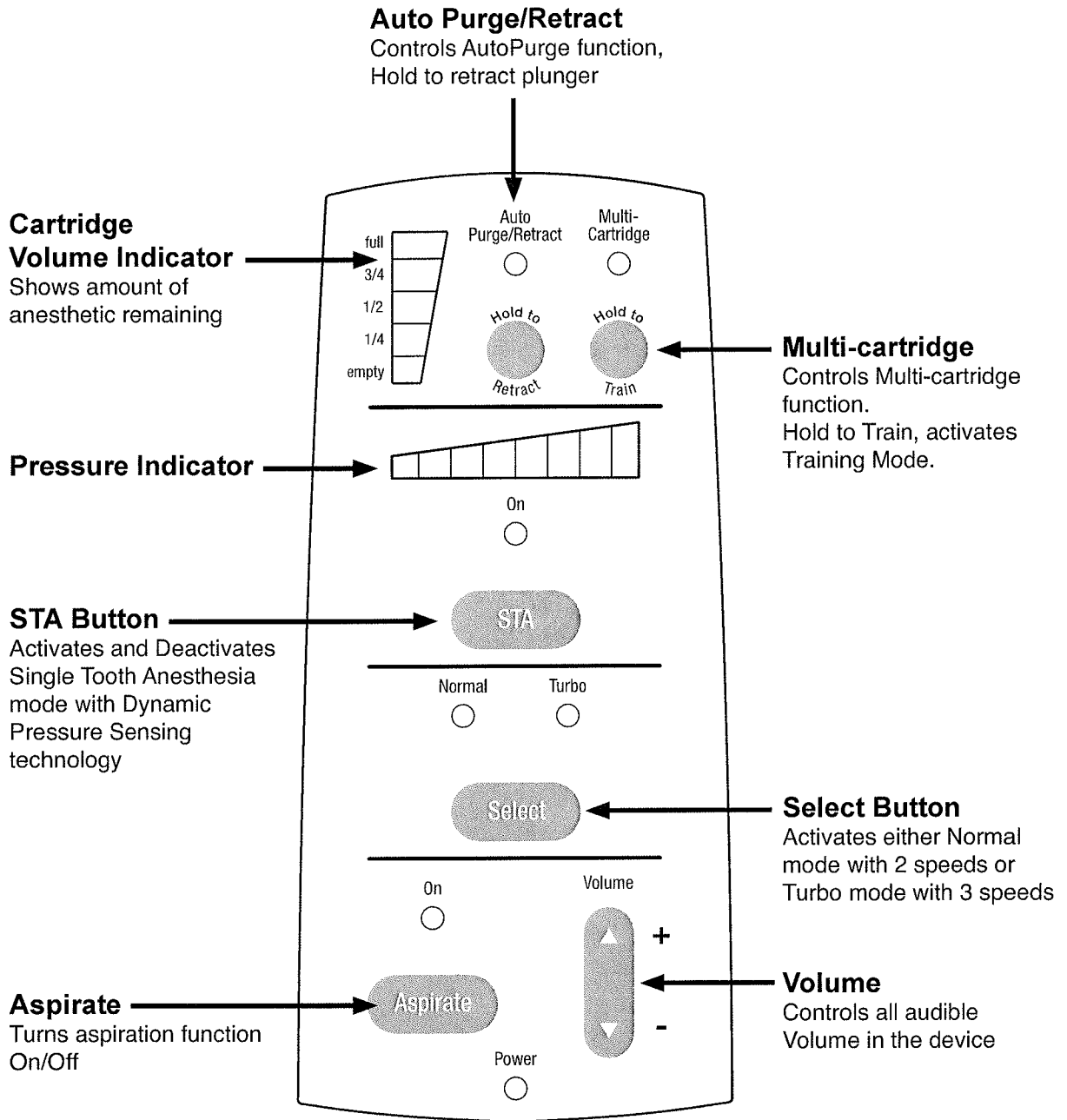

# FEATURES

## STA Single Tooth Anesthesia System

1. Drive Unit
2. Power Switch (@ back of drive unit)
3. Power Cord (US version shown)
4. Anesthetic Cartridge Holder
5. Anesthetic Cartridge
6. Foot Control w/Air Hose
7. Cartridge Holder Socket
8. Plunger w/O-Ring
9. Handpiece Receptacle (both sides)
10. Foot Control Receptacle
11. Needle
12. Remaining Cartridge Quantity Indicator
13. Auto Purge/Retract Indicator
14. Auto Purge/Retract Button/Hold to Retract
15. Multi-Cartridge Indicator
16. Multi-Cartridge Button/Hold to Train
17. STA Pressure Sensing Scale
18. STA Mode
19. STA Button
20. Normal Mode Indicator
21. Turbo Mode Indicator
22. Mode Selector Button
23. Aspirate Indicator
24. Aspirate Button
25. Audio Volume Adjust Buttons
26. Power Indicator
27. Drain hose exit port
28. 1/4" - 20 Mounting Nut

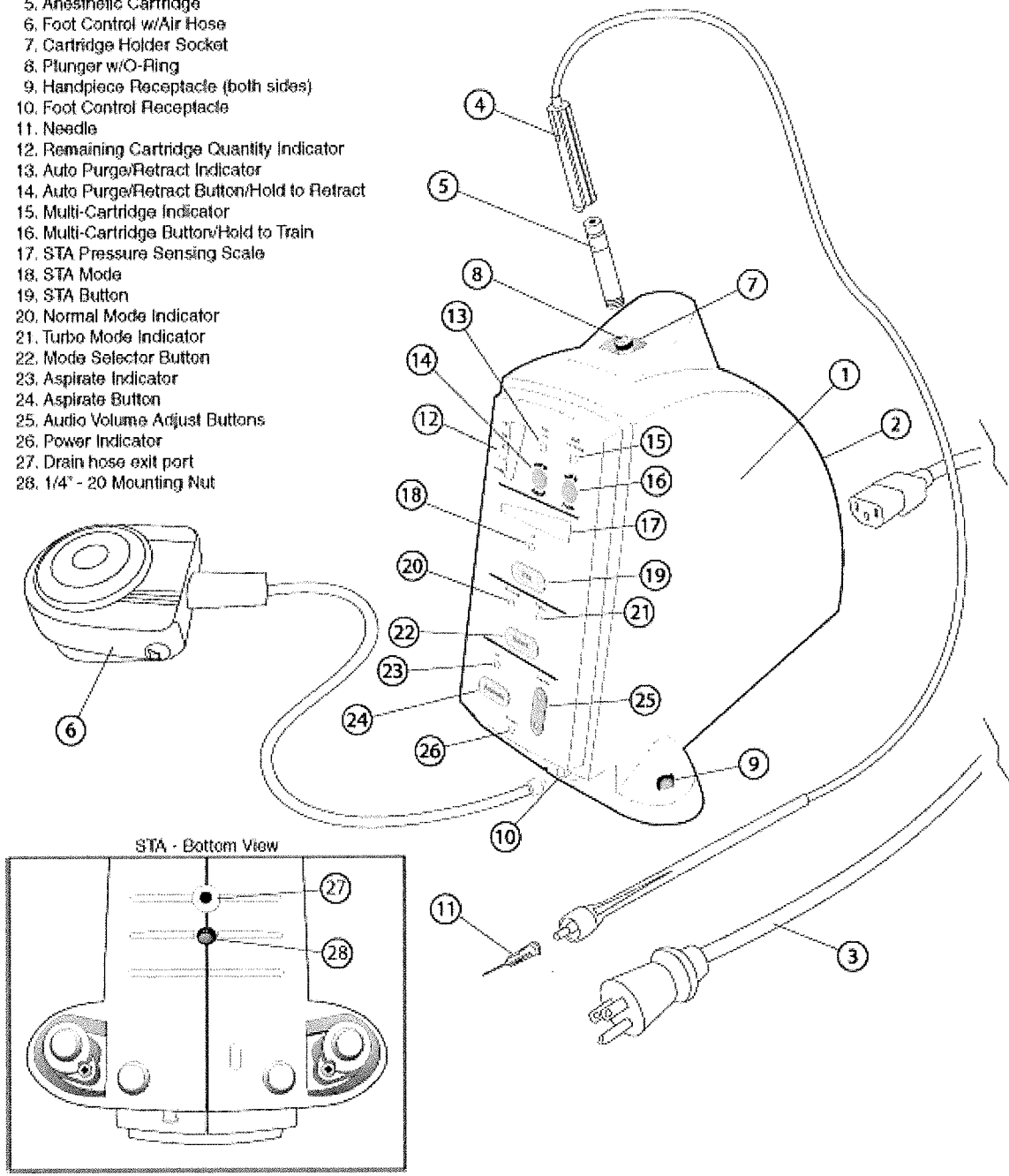

## BASIC OPERATION

### OPERATION

#### Set Up

Connect foot control hose to front outlet on drive unit. Hand-tighten snugly.

Position drive unit on a flat, level surface within 3' of patient. (The **STA Wand™** hand-piece micro tubing is 5' long from the drive unit to the handpiece.)

Plug the drive unit electrical cord into the back of the unit and then to a power outlet. Place the STA System and power cord in an accessible location such that in case of emergency, the unit may be powered down or unplugged quickly.

**Note:** Do not place STA™ unit within 12 inches of other electrical devices such as electro-surgery units as they may cause interference.

**Warning:** There may be possible safety hazards associated with the external radiofrequency interference (RFI) or electromagnetic radiation which may affect the safe operation of this device and therefore should be avoided.

#### Power 'On/Off'

Press power switch on the back of the drive unit to turn system power 'On' and 'Off'. Plunger will automatically retract to 'down' position when unit is turned 'On'. When first turned on the STA is set to the default modes. The STA will self-calibrate in 5 seconds, having no effect on the user.

#### STA Handpieces

Two types of handpieces are available for the STA System. The STA Wand™ hand-piece and the STA SafetyWand™ handpiece with safety engineered sharps protection to aid in the prevention of needlesticks. Specific instructions for each version of the handpiece are provided in the following sections.

**Note:** Only use handpieces, needles and other components with the STA System that are manufactured or recommended by Milestone Scientific.



## BASIC OPERATION

### STA Wand™

#### Product Description

The STA Wand™ handpiece is shaped to allow a pen-type grasp for accurate needle insertions. However, the handpiece can be broken to create a short, easily controlled needle handle for injections into tight areas. (See illustration)

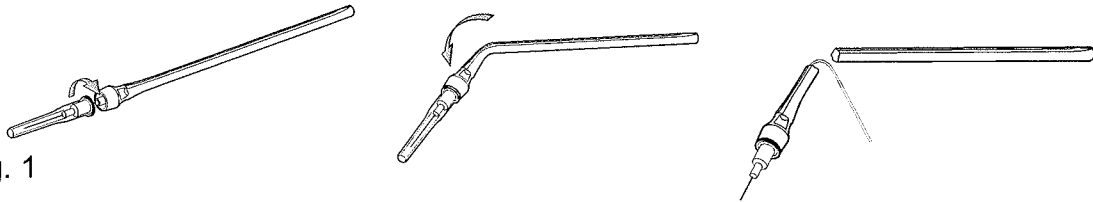

Fig. 1

#### OPERATION:

Familiarize yourself with the operation of the STA Wand™ by practicing with the device prior to clinical use.

1. Turn drive unit on.
2. Remove a needle from the sterile packaging. Maintain sterility.
3. Hold the STA Wand™ handpiece firmly. Place the needle into the open end of the handpiece and rotate needle. It is critical that the needle is firmly secured to the handpiece.

**Note:** The STA handpiece is also available with a selection of needles that are pre-attached and bonded to the handpiece. The handpiece equipped with the 30 gauge ½ inch needle is optimized for the STA-Intraligamentary injections. Contact your dealer for availability.

4. After the needle is attached to the handpiece, place the needle cap into wand holder on either side of the STA unit
5. Slide the diaphragm end of cartridge (with metal band) into cartridge holder, push cartridge firmly and completely into the holder until you feel the spike penetrate the rubber diaphragm.
6. Place open, flange end of cartridge holder into the cartridge holder socket on top of the unit, and rotate counter-clockwise 1/4 turn.
7. After attaching the cartridge holder to the drive unit, the STA unit will automatically purge the air from the tubing and needle. The handpiece is now primed and ready for use.

**Warning: The flow rate during the prime/bolus cycle is 0.0691 ml/second. The maximum pressure alarm is disabled during the priming (i.e., purge) phase. The alarm is re-enabled immediately following this operation.**

## BASIC OPERATION

**Note:** If you experience difficulty puncturing a cartridge it may be due to variations in the rubber diaphragm material. Try these four solutions to correct the situation:

- Place the cartridge into the holder; gently rotate the cartridge stopper 360 degrees against the spike two or three times. Then press firmly into the holder, puncturing the cartridge. A slight twisting motion as you press may also help puncture the cartridge.
- Place cartridge into cartridge holder. Place cartridge against a firm surface or counter top and press quickly and firmly down.
- Swab rubber diaphragm with alcohol which acts as a lubricant.
- Place the cartridge into the holder. Press firmly against spike, stretching the rubber diaphragm for 5-6 seconds. Release and immediately re-push rapidly and firmly against the spike.

### One Handed Needle Recapping Technique

1. After the needle is attached to the handpiece, place the needle cap into wand holder on either side of the STA unit.

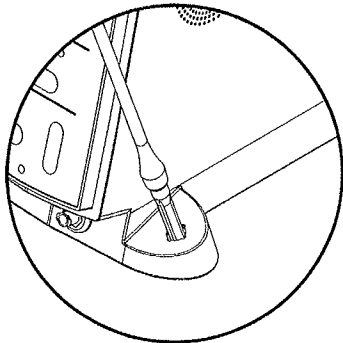

Fig. 2

2. Hold needle cap firmly with one hand, remove the needle from the cap with the other hand by pulling straight out from the cap. Do not twist. (Cap remains in receptacle on the side of the unit).
3. Between injections, lightly set the needle back into the cap. Do not press into the cap. This is a temporary holding dock for the needle.
4. When ready to use the handpiece and needle, simply remove the handpiece and needle from the cap. Return the needle to the cap when not in use.
5. When the procedure is completed, firmly press the needle into the cap on the side of STA unit, locking the cap back on the needle. When locked in place and keeping your hands behind needle point remove the cap with the attached needle from the unit and discard in an approved manner.

**Note:** Recap needle when medically necessary or when no other alternative exists.

## BASIC OPERATION

### STA SafetyWand™

#### Product Description

The STA SafetyWand™ (Fig. 3) handpiece is designed with safety engineered sharps protection to aid in the prevention of needlesticks.

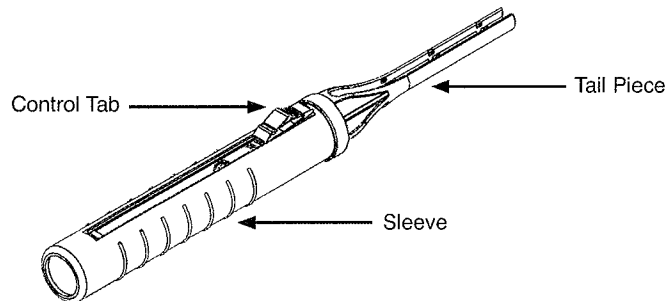

Fig. 3

#### OPERATION:

The operation of the **STA SafetyWand™** control tab requires only a gentle and gradual motion to engage or release the control tab which protracts and retracts the needle. Familiarize yourself with this operation by practicing with the device prior to clinical use.

#### To Protract:

**Depress the back portion of the CONTROL TAB and slide forward to fully protracted position. (See illustration)**

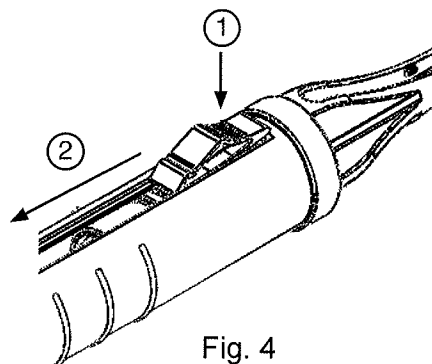

Fig. 4

## BASIC OPERATION

**To Lock:**  
Once in the fully protracted position, depress the forward portion of the CONTROL TAB to lock.

**To Unlock:**  
Depress the back portion of the CONTROL TAB and release.

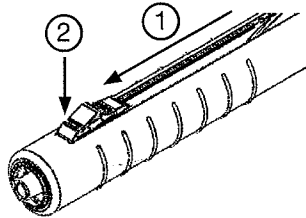

Fig. 5

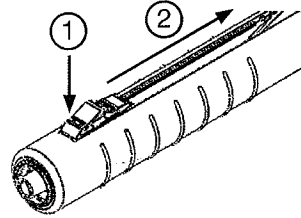

Fig. 6

### Preparation:

1. Turn drive unit on.
2. Remove the sterile STA SafetyWand™ handpiece from package. Maintain sterility.
3. Attach the needle:
  - a. Hold the STA SafetyWand™ in one hand.
  - b. Attach a standard luer lock needle by depressing the back portion of the control tab and by sliding it forward. To lock in the protracted position, slide control tab forward and depress the forward portion of control tab.
  - c. While securely holding the STA SafetyWand™, place the end of a standard luer lock needle into the open end of the STA SafetyWand™ and rotate until firmly secure.
  - d. Place the handpiece on the side of the drive unit when not in use. Once secured, retract the needle by depressing the back portion of the control tab and pull handpiece straight out of cap. Do not twist. **(Cap remains in the receptacle on side of unit.)** While not in use, replace the retracted handpiece onto the cap on the side of the drive unit.
4. Load the anesthetic into the STA SafetyWand™ and attach the cartridge holder to the drive unit by twisting the holder counter-clockwise approximately ¼ turn in the STA drive unit. The STA System will automatically purge the air from the tubing and needle. The handpiece is now primed and ready for use.

## BASIC OPERATION

### Directions for STA SafetyWand™ Use:

1. Remove the handpiece (with attached needle) from the cap on side of the drive unit. Protract the needle by depressing the back portion of the control tab, gently sliding it forward all the way (Fig. 7), and depressing the forward portion of control tab to lock into the protracted position (Fig. 8). The control tab becomes "self-locked" into the protracted position. Perform the injection.

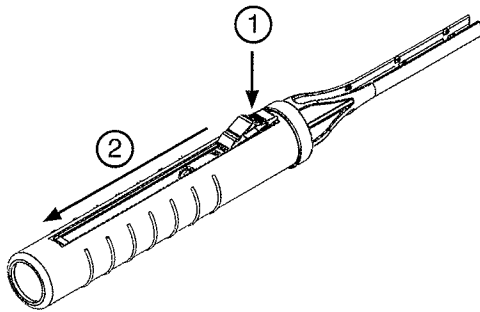

Fig. 7

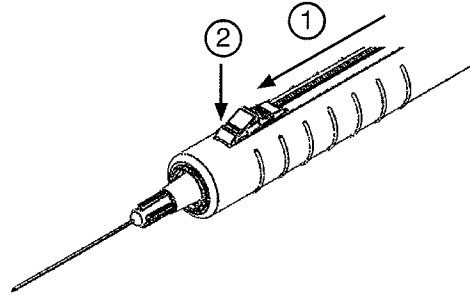

Fig. 8

2. **To retract the needle using one hand, depress the back portion of control tab with your finger or thumb.** This will automatically retract the needle into the safety position. You will hear and see the control tab and needle "lock" in the retracted safety position (Fig. 9, 10).

**To Retract:**  
Depress the back portion of  
the CONTROL TAB to release

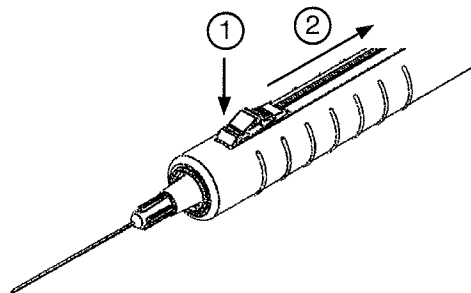

Fig. 9

**Auto-retraction:**  
The needle will automatically  
retract when released from the  
protracted position.

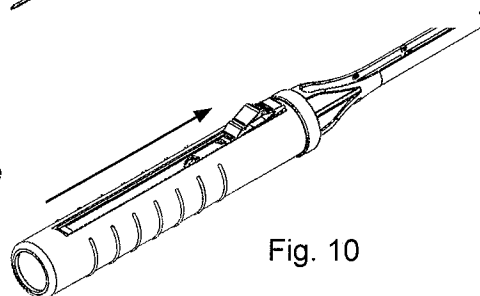

Fig. 10

## BASIC OPERATION

### Auto-retraction:

The needle will automatically retract when released from the protracted position.

3. Place the handpiece on the side of the drive unit when not in use. While still in the retracted state and using the needle cap as a guide, slide the handpiece into the cap on the side of the drive unit.

### Disposal:

1. After last injection, withdraw needle from tissue and retract into the back position.
2. Press down firmly on the front end of the control tab with your thumb-nail and push it into the sleeve
3. Press hard enough to make the forward portion of the control tab “break-through”, lodging itself into the sleeve. This will prevent the handpiece from protracting.

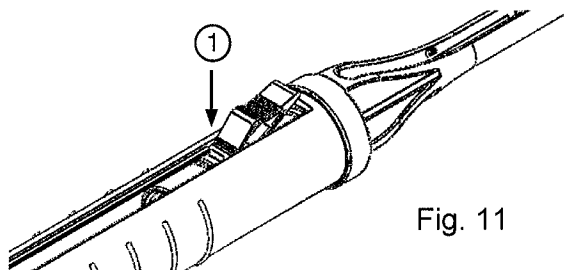

Fig. 11

4. Directly discard in an approved manner, e.g., a sharps container.

**CAUTION:** Do not use with needles longer than 1.25 inches with the STA SafetyWand™.

**CAUTION:** Maintain sterile conditions.

## BASIC OPERATION

### WARNINGS:

#### Single Use ONLY:

The STA Wand™/SafetyWand™ handpiece and tubing assembly, as with any syringe, opens a fluid pathway directly to the patient. **This device is for single use only. It must not be re-sterilized** and must not be used on successive patients or the same patient at a later visit. Reusing The STA Wand™ /SafetyWand™ handpiece places the patient at risk. The anesthetic cartridge must not be reused on multiple patients.

#### Do not bend needle during use:

Deformed or bent needles may interfere with the proper operation of the STA Wand™ /SafetyWand™

#### Lubricate the “O” Ring and Plunger:

A properly maintained and lubricated 'O' Ring is necessary for effective functioning of the system. The following procedure is recommended:

- a. Check 'O' Ring for cracks, deterioration, or lack of lubrication daily
- b. If cracked or deteriorated, replace at once.
- c. If dry, lubricate with silicon gel. While plunger is extended, lightly lubricate plunger shaft with silicon gel. This will enhance smooth performance.

**STERILE**, unless individual plastic package is opened or damaged.

### CAUTIONS:

- Do not use the SafetyWand™ with needles longer than 1.25 inches
- Federal law restricts this device to sale by or on the order of a physician or dentist.
- Maintain sterile conditions.

## BASIC OPERATION

### Additional Important Information

**STA System** introduces a revolutionary technology to local anesthesia injections called Dynamic Pressure Sensing (**DPS™**) Technology. It is important that the operator fully understand several aspects of DPS technology to make the most of this exciting new breakthrough. The STA System with DPS™ technology provides the operator with **continuous real-time pressure feedback** throughout the injection process. This will be a new experience for the practitioner and it is important to understand many new clinical implications of having continuous feedback. It is analogous to using a highly accurate “apex locator” in that the technology allows one to make subtle clinical adjustments resulting in a difference between clinical success and failure. The STA System is a powerful technological clinical tool when used correctly.

**IMPORTANT:** It is common that when performing the **STA-Intraligamentary injection** (described starting on page 21) **that the operator may move the needle to several different locations to identify the optimal needle-to-ligament position based on DPS feedback.** This “searching” method validates how DPS with real-time feedback provides critical information to the user. With all other injection devices the operator is unaware if a correct needle position has been established, typically using the first location.

**IMPORTANT:** It is common that when performing the **STA-Intraligamentary injection that the operator will encounter an “Over-Pressure” condition.** An Over-Pressure condition is when the maximum pressure of the unit has been reached and the unit will sound an alert and stop. This is typically as a result of either a clogged needle tip or excessive hand-pressure being applied to the hand-piece blocking anesthetic flow. With either of these situations the needle must be removed and the injection restarted. The ability to accurately and consistently detect needle blockage using the STA System validates the critical importance of this technology to the clinician.

#### Auto-Calibration:

**IMPORTANT:** When the STA System is first turned “On” the unit will perform an auto-calibration of the system, during the initial 5 seconds. During this time Do Not install a cartridge holder onto the drive unit. Note: periodically during use the unit will perform auto-calibration; this has no effect on operation.



## BASIC OPERATION

### Basic Modes of Operation

The STA System is equipped with three basic modes of operation. They are:

1. STA mode, which has a single anesthetic injection flow rate. This mode is activated when the unit is turned on.
2. Normal mode, which has 2 anesthetic injection flow rates.
3. Turbo mode, which has 3 anesthetic injection flow rates.

The user may change between modes during any procedure and the selection is retained while cartridges are replaced. When the STA System is turned off and then back on, the default setting is the STA mode.

**STA Mode:** Provides the user with real-time Dynamic Pressure Sensing (DPS™) technology while injecting using the *ControlFlo*™ rate. Aspiration default is set to “ON” and can be changed by the user.

**Normal Mode:** In this mode the system has two flow rates, *ControlFlo*™ and *RapidFlo*™. The DPS™ (See section on DPS technology) pressure sensing technology is not activated. Aspiration is set to “On” and can be changed to “Off” by the user.

**Turbo Mode:** The Turbo mode provides the user with an additional speed, *TurboFlo*™; all three speeds are controlled by the foot-control pedal. Aspiration is set to “On” and can be changed to “Off” by the user.

## BASIC OPERATION

### Foot Control Operation

The foot control supplied with the STA System is an air activated switch. Slight pressure = *ControlFlo*<sup>™</sup> (1 cc per 207 seconds). Modest pressure = *RapidFlo*<sup>™</sup> (1 cc per 35 seconds). When selected, additional pressure engages *TurboFlo*<sup>™</sup>. The *TurboFlo*<sup>™</sup> (1 cc per 17 seconds) delivers the anesthetic solution 2 times faster than *RapidFlo*<sup>™</sup> and must be used with extreme care.

**Warning:** *ControlFlo*<sup>™</sup> is the only rate that should be used when performing Palatal and STA-Intraligamentary injections. *RapidFlo*<sup>™</sup> and *TurboFlo*<sup>™</sup> should never be used for these injections as they can result in pain and tissue damage.

**IMPORTANT:** *ControlFlo*<sup>™</sup> should be used at the beginning of **ALL** injection techniques. It provides a controlled and safe administration that normally results in little or no discomfort. Once initial "numbness" has occurred you may decide to switch to a more rapid rate, i.e. *RapidFlo*<sup>™</sup> or *TurboFlo*<sup>™</sup> during infiltration injections and Inferior Alveolar block injections. Typically ¼ of the cartridge should be administered using the *ControlFlo*<sup>™</sup> rate before switching to a more rapid rate of delivery.

*TurboFlo*<sup>™</sup> is intended to be used only after initial anesthesia (numbing) has occurred for the Inferior Alveolar Nerve Block Injection or a Supraperiosteal Infiltration Injection. The oral tissues that are affected by these injections are composed of loose, elastic tissues that can accommodate this rapid rate; however, caution should always be used, and operator judgment is critical to performing a safe and effective injection.

Always be certain that the foot control hose is firmly attached to the unit. **Any air leaks will degrade the operation.** Practice using the foot control to become comfortable with the operation and pressure required to activate the various delivery rates.

## BASIC OPERATION

### Cruise Control Function

This feature allows the operator to engage the *ControlFlo*™ without continuously depressing the foot control. This feature is available in the Normal, Turbo and the STA settings.

#### To use Cruise Control:

1. Begin *ControlFlo*™. Listen to beeps.
2. After 3 beeps a voice will say CRUISE. This opens a 5 second window during which you can activate the cruise control.
3. Immediately remove foot from foot control. Cruise control is engaged and a voice will say SET.

**Note:** You will not hear the word SET spoken in the STA Mode when cruise control is engaged.

4. If you do not want to engage cruise control, do not remove foot from foot control during this window.
5. To disengage cruise control, depress foot control and release or press firmly for faster speeds.

## **BASIC OPERATION**

### **Manual Purge and AutoPurge**

Prior to making any injection, all of the air should be “purged” from the microtubing and from the needle.

### **AutoPurge Operation**

The STA System can automatically purge with the AutoPurge feature. When enabled, each time a new cartridge is attached to the drive unit the plunger automatically advances, moving the anesthetic through the tubing to purge the air from the system. A small amount of anesthetic can be observed at the end of the needle following a successful purge. The unit is preset at the factory to use AutoPurge as the default.

### **To Use AutoPurge**

1. Load and attach a cartridge holder to the drive unit, twisting it  $\frac{1}{4}$  turn counter-clockwise.
2. The plunger will automatically advance. This will expel the air from the tubing and from the needle. A small droplet of anesthetic at the tip of the needle indicates a successful purging.
3. The Anesthetic Solution Volume Gauge will now be illuminated to FULL, indicating the unit is ready to use.

### **Manual Purge Operation**

If the operator desires not to use the AutoPurge, it can be turned off, activating the manual purge function. To manually purge the system, press the AutoPurge button, indicator light is now turned off and the air is NOT automatically purged from the tubing. Depress the foot pedal at which time the drive unit automatically extends the plunger a preset distance to purge air from the micro tubing and the needle.

## BASIC OPERATION

### Multi-Cartridge Feature

This function is useful when a second or third cartridge is required during a single procedure using the same disposable STA Wand™ and there is no need to purge air from the handpiece and tubing as it was previously purged. This operation will save unnecessary loss of anesthetic solution when using more than one cartridge.

1. While the STA plunger is completely retracted, press the Multi-Cartridge button. Indicator light will illuminate ON.
2. Remove the empty cartridge and replace with a new full cartridge. Insert cartridge holder onto unit. (The device will NOT purge itself).
3. Continue injection.
4. STA will default back to Multi-Cartridge OFF mode following the end of the injection. The Multi-cartridge mode will turn off automatically after 60 seconds if a new cartridge is not attached to the drive unit.

## BASIC OPERATION

### Plunger Operation

When the STA System is first turned on, the plunger retracts and parks in the retracted position. Inserting the cartridge automatically engages the plunger and purges the tubing. The system is ready when the indicator is illuminated, showing a FULL volume.

As the plunger is extended dispensing anesthetic, the volume indicator light will show the amount of anesthetic solution remaining in the cartridge. As the plunger is fully extended, an audible warning beep is sounded. This indicates that the cartridge is empty. When the cartridge is fully emptied or when the cartridge holder is removed, the plunger will automatically retract into the drive unit. If the Auto-Purge/Retract is not set, the plunger can be retracted by pressing the Hold to Retract button.

### Plunger Retraction

Retraction of the plunger can be performed using any of the following three methods:

1. When the "Auto-Purge/Retract" feature is activated (noted by the illuminated green LED on the front panel) the plunger will automatically retract when the cartridge holder is removed from atop of the STA drive unit.
2. Manual retraction of the plunger. When the "Auto-Purge/Retract" feature is not activated it is necessary to manually retract the plunger during use. This is accomplished by depressing the multipurpose "Hold to Retract" button for greater than 4 seconds.
3. Retraction of the plunger to the return "home" position will occur after the plunger has fully expressed the content of an anesthetic cartridge. (This will occur irrespective of the "AutoPurge/Retract" feature state and does not require the removal of the cartridge holder from the STA drive unit.)

**NOTE:** To turn the "Auto-Purge/Retract" feature "On" and "Off" use the multipurpose "Hold to Retract" button. You may toggle it "On/Off" by depressing and releasing the button for less than 4 seconds.

### Removal of Cartridge

Ensure plunger is fully retracted. Remove the cartridge holder from the cartridge socket drive unit by rotating cartridge holder clockwise 1/4 turn. Remove used cartridge by pushing with finger placed into slots in side of holder. If continuing injection procedure, remove and discard the used cartridge and insert a new full cartridge into the cartridge holder and continue.

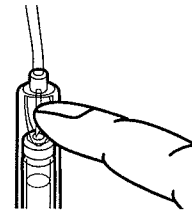

## BASIC OPERATION

### Aspiration

#### 1. **IMPORTANT ASPIRATION PRETEST**

It is recommended that an aspiration pretest be performed prior to any injection requiring aspiration. This simple pretest will confirm that the disposable handpiece, anesthetic cartridge and attached needle are free from air leaks which might compromise aspiration efficiency.

Once the drive unit purge cycle is completed, orient the needle horizontally with the bevel down or to the side. Pretest will not work if needle bevel is in the up position.

Express anesthetic extra-orally at the *ControlFlo™* rate (slow speed). Release the foot control and observe the drop of anesthetic at the end of the needle. If a drop is retracted and returns to the needle tip at the end of the aspiration cycle, in about 5 seconds, aspiration is functioning properly.

If droplet does not retract, do the following in the order listed:

- i. Re-tighten needle hub and retest
- ii. Replace cartridge and retest
- iii. Replace the STA Wand™ handpiece and retest
- iv. Lubricate O-Ring and retest
- v. Replace O-Ring and retest

This test should be repeated with each new anesthetic cartridge when aspiration is to be used. Rubber stopper movement in the cartridge can also be monitored during aspiration as a further assurance.

2. Aspiration "On/Off" feature: Aspiration can be performed automatically when the Aspiration feature is set to the "On" position (indicated by the green LED light on the front panel). When this feature is set to the "On" aspiration state, aspiration can be performed in all three modes (STA, Normal & Turbo). To change the setting before or during a procedure, press the "Aspirate" button on the front of the control panel.
3. **TO ASPIRATE:** Be sure aspiration mode is activated (light on). Aspiration is initiated by lifting your foot from the foot control in STA, Normal or Turbo mode. If in cruise control, tap the foot control to activate. When the aspiration function occurs, the plunger is retracted a preset distance, then automatically returns to its original position. Positive aspiration will show blood in the needle hub and/or tubing contained in the handpiece.

## BASIC OPERATION

### Audible Signals and Audio Volume control.

Your new STA System is equipped with a number of audible indicators that monitor speed of anesthetic delivery, and status of how much anesthetic has been delivered. While using the STA feature, it provides an audible feedback to identify the correct position of the needle within the periodontal ligament tissues to successfully perform a STA-Intraligamentary injection.

The device has a system-wide VOLUME control, whereby the audio volume may be controlled. Press to either increase or decrease the overall audio volume of the device. This change will be retained for future use. The audible sounds cannot be fully turned off. Ensure audio is functioning properly prior to beginning the injection.

### Cartridge Volume Gauge and Audible Cartridge Tone Indicator

The STA drive unit monitors the amount of anesthetic used by visual and audible indicators. The front panel of the drive unit has LED indicators which light up showing the amount of anesthetic solution remaining. The unit will also “bong” once when  $\frac{1}{4}$  cartridge is expressed, twice when half is expressed and three times when  $\frac{3}{4}$  is used. Empty is indicated by a double “chirping” sound.

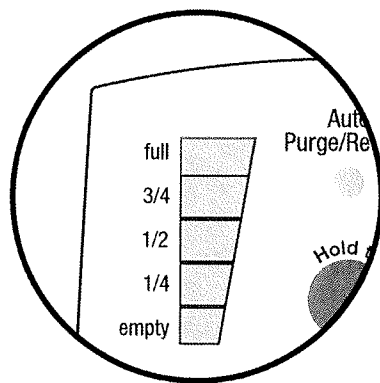

Fig. 12



## **BASIC OPERATION**

### **Dynamic Pressure Sensing (DPS™) Technology**

The STA System is equipped with an innovative DPS™ Technology which provides the user with “Real-Time” feedback of the actual pressures read at the tip of the needle during an anesthetic injection. The real time pressure is read many times per second and shown on the pressure sensing gauge. Clinical research has shown that successful intraligamentary injections are associated with relatively high injection pressures. The DPS technology provides the user with a feedback mechanism to indicate these higher pressures and thus guide the proper placement of the needle tip. The DPS Technology is only activated in the STA mode.

### **STA-Intraligamentary Injection**

The STA System provides DPS™ technology that is capable of identifying specific tissues during the dental injection. The STA mode allows the practitioner to accurately identify the periodontal ligament tissue. It also enables the clinician to maintain the correct needle position within the periodontal ligament when performing the newly described STA-Intraligamentary Injection. Developed by Dr. Mark Hochman, the STA-Intraligamentary Injection represents a new concept in local dental anesthesia techniques.

Developed by Dr. Mark Hochman, the STA-Intraligamentary injection represents a new concept in local anesthesia techniques. The STA System is the only anesthesia system that provides clinicians with the 3 critical elements of information when performing a STA-Intraligamentary Injection:

1. It guides the clinician to position the needle tip to the periodontal ligament.
2. It provides ongoing feedback that ensures the needle has not moved during the procedure.
3. It alerts the dentist if there is a needle blockage or any leakage in the system.

## BASIC OPERATION

### Performing the STA-Intraligamentary Injection

1. Turn the STA drive unit to "On". The system will default to the STA mode.
2. Load and attach the STA bonded handpiece with the pre-attached bonded 30 gauge ½ inch needle and the appropriate anesthetic. The unit will automatically purge the air from the system. Rest the handpiece in the cap holder.
3. While holding the STA handpiece in a pen-like grasp, place the needle into the gingival sulcus of the tooth to be anesthetized. Simultaneously, activate the *ControlFlo*™ rate by depressing the foot control. It is important to gently and slowly advance the needle within the sulcus, as if it were a periodontal probe. It is highly recommended that the clinician use a finger rest to control and stabilize needle movements.
4. The STA System provides a continuous audible and visual feedback to guide the needle tip to the periodontal ligament. As the foot control is depressed, the device will begin sensing. The user will then hear the word "Cruise" at which time the cruise control function can be engaged by removing one's foot from the pedal. If the operator's foot is removed from the foot control within 4 seconds of hearing the spoken word "Cruise" the unit will engage cruise control.
5. In the STA mode, the DPS technology provides real time pressure feedback via:
  - a. The visual Pressure Sensing Scale (Gauge) comprised of a series of orange, yellow and green LED lights. The orange LED's indicate minimal pressure, the yellow LED indicate mild pressure and the green LED's indicate moderate pressures indicative of the periodontal ligament tissue.
  - b. The auditory Pressure Sensing Scale is composed of a series of triple ascending tones "beep, beep, beep". Increasing pressure is indicated by the triple ascending sequence. When the periodontal ligament is identified, the user will hear the letters "PDL" spoken, followed by a series of extended tones "beeeep, beeeep" indicating correct needle positioning.

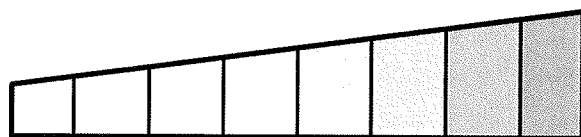

Fig. 13

## BASIC OPERATION

### Performing the STA-Intraligamentary Injection (continued)

**Note:** It is typically found when performing the STA-Intraligamentary injection that it is often necessary to relocate the needle tip to find the periodontal ligament tissues. The operator should not be concerned that it may take several attempts to find the optimal location. Using DPS™ technology, the user can be confident that the optimal location has been identified

The continuous DPS™ technology provides the user with important on-going information that the needle has not moved from the optimal location during the entire injection process. The DPS™ feedback will also alert the operator to the proper hand pressure applied to the handpiece. Excessive pressure can result in “blockage” of flow of anesthetic solution. This will be detected and result in an “over pressure” condition.

An “over-pressure” condition is when pressures exceed the maximum pressure programmed in the unit. The maximum pressure generated by the STA system is 450 psi. Pressures exceeding this will trip the occlusion alarm and prevent any further administering of anesthetic. The STA drive unit will sound an auditory and visual alarm. Do not operate this equipment if any alarm has been activated for any reason. The clinician can then restart the injection and reset the alarm. It might be necessary to re-position or move the needle to a new location.

**Note:** It is not uncommon for an over-pressure condition to occur, this emphasizes an importance of being able to monitor real-time pressure with DPS technology. This may occur as a result of excessive hand pressure on the STA-Wand™ handpiece. It may also result from a blockage or clogging of the needle. In either situation, the needle must be relocated. If the overpressure situation persists, remove the needle from the patient’s mouth to determine if the needle is “blocked” or “clogged”. If the needle is clogged it will need to be replaced prior to reuse. In the event of an occlusion, the bolus amount generated when the system is in the STA mode is 0.077 cc when the blockage is released.

**Note:** Execute the following procedure in order to test the occlusion alarm. The operator may test for an over-pressure condition by occluding a needle and using the STA mode. The pressure will build in the STA mode and the alarm will sound.

## BASIC OPERATION

Based on the auditory and visual pressure sensing feed-back, it is not unusual for the operator to have to reposition the needle several times before locating the proper position of the needle within the periodontal ligament. Additionally, slight needle movements can result in rapid loss of pressure. The user will need to withdraw and reposition the needle to establish an effective periodontal ligament location.

Removal of the needle from the ligament should be performed mid-way during the aspiration cycle to prevent a back-spray of anesthetic solution into your patient's mouth. Since the injection is performed under pressure, if the needle is otherwise removed, the patient's mouth will be sprayed with bitter tasting anesthesia. Therefore, the operator is advised to remove the needle during aspiration, i.e. when the STA drive unit is retracting during aspiration.

### **Drug Selection:**

The clinician should use his/her own judgment as to the anesthetic drug selection and volumes used. The following information serves only as a guideline, and clinicians are advised to refer to the appropriate drug manufacturers for specific recommendations. In addition, clinicians are advised to review the current dental literature and dental textbooks for guidance on recommended dosages and drug recommendations.

When using 2% Xylocaine Hydrochloride 1:100,000 Epinephrine or other local anesthetics formulated with a 2% concentration the following recommendations are made:

- A drug volume of 0.9 ml is recommended for single rooted teeth.
- A drug volume of 1.8 ml is recommended for multi-rooted teeth.

When using 4% Articaine Hydrochloride or other local anesthetics formulated with a 4% concentration the following recommendations are made. **NOTE:** it is recommended when using 4% Articaine hydrochloride that only a 1:200,000 vasoconstrictor concentration be used:

- A drug volume of 0.5 ml is recommended for single rooted teeth.
- A drug volume of 0.9 ml is recommended for multi-rooted teeth.
- The use of 2% local anesthetics containing a vasoconstrictor concentration of 1:50,000 parts is not recommended for administration of an intraligamentary injection.
- The use of 4% local anesthetics containing a vasoconstrictor concentration of 1:100,000 parts is not recommended for administration of an intraligamentary injection or palatal injections (AMSA & P-ASA).

## BASIC OPERATION

### Training Mode

The STA System comes with a unique training mode that provides additional voice prompts not found in the standard mode. It is enabled by pressing and holding the "HOLD TO TRAIN" button for 4 seconds. It is highly recommended that the Training Mode be used while the practitioner becomes familiar with the STA system.

1. Depress the Hold to Train button for 4 seconds and the device replies with "TRAINING MODE ON". The button may also be held while powering up the STA unit.
2. Load the anesthetic cartridge into the handpiece and attach the handpiece to STA unit. The STA unit automatically purges the handpiece and replies with "READY".
3. Press **STA** button and the STA unit replies with "STA MODE".
4. Depress the foot control, the STA unit replies "SENSING". An audible tone indicates the device is expressing the anesthetic. After 3 beeps a voice will say "CRUISE". This opens a 5 second window during which you can activate the cruise control. Immediately remove foot from foot control. Cruise control is engaged and a voice will say "SET".
5. As pressure builds, the indicator lights change from orange to yellow to green, the device also says "ASCENDING" and uses a unique 3-note tone.
6. The correct injection pressure is indicated when the device repeats "PDL" and provides the PDL slow tone.

**The Training Mode is useful for all modes as the STA System is equipped with an audible voice that will explain the various audible indicators. This will assist the user in quickly learning the proper operation of the STA System. The Training Mode may be deactivated at any time at the user's discretion.**

## BASIC OPERATION

### Global Default Setting

The STA unit may be set to a global default by pressing the volume button during power-up. This sets the device to the following:

1. STA Mode is "ON" and set to tones.
2. AutoPurge/Retract is set to "ON".
3. Aspiration is set to "ON".
4. The device will use tones to indicate the various flow rates.
5. The device will chime when the cartridge is empty,  $\frac{1}{4}$ ,  $\frac{1}{2}$ , and  $\frac{3}{4}$  full.
6. The audible volume is set at the midpoint.
7. The Cruise Control is enabled.
8. The Multi-Cartridge feature is set to "OFF".
9. The STA will automatically notify you when to lubricate the O-ring and plunger.

Features 1-6 may also be programmed by holding down the Select button while the unit is turned on. The Select button must be held down through the entire setting. When released, the feature settings changes are saved.

## MAINTENANCE AND CARE

### Maintenance and Care

1. **Cleaning the Drive Unit**  
After each use the unit should be disinfected. Spray disinfectant on a soft towel and wipe the unit. Do not spray directly onto unit. A barrier system can also be used over the drive unit.
2. **“O” Ring and Plunger Maintenance and Lubrication**  
A properly maintained and lubricated “O” Ring is necessary for effective functioning of the aspiration cycle. We recommend that the following procedure be initiated:
  - a. Check “O” Ring for cracks, deterioration, or lack of lubrication daily.
  - b. If cracked or deteriorated, replace at once.
  - c. If dry or not lubricated, lubricate with silicone gel provided in handpiece box.
  - d. While plunger is extended, lightly lubricate plunger shaft with silicone gel. This will enhance smooth performance.

**NOTE:** Unit will automatically remind you to lubricate after every 24 cycles.

**WARNING: When AutoPurge/Retract button is pressed and held down while the power is turned ‘On’ the plunger will automatically fully extend. See plunger changing and sterilizing.**

3. **Plunger and “O” Ring Changing and Sterilizing**  
Plunger and O-Ring Assembly may be removed for sterilization or replacement.  
**Do not activate cleaning mode with cartridge in place.**

#### Removal of plunger and O-Ring assembly (Cleaning Mode)

Remove cartridge holder from socket if present. Turn off the device, press and hold the AutoPurge/Retract button and then turn the device back on. The drive unit will automatically extend the plunger and O-Ring assembly for removal. Unscrew the plunger from the drive unit by rotating it counter-clockwise.

## MAINTENANCE AND CARE

A recommended autoclave procedure is as follows:

1. Remove plunger from the STA drive unit.
2. Manually clean with a soft brush, taking care to remove all lubricant and debris. Remove O-Ring.
3. Rinse and dry plunger. Inspect for corrosion or other damage.
4. Place plunger in an autoclave bag and seal.
5. Sterilize using steam autoclave (moist heat steam under pressure) following manufacturer's instructions for sterilization of steel surgical instruments. Typical parameters are: Time 15-30 minutes, Temperature 250° F (121° C), pressure 15psi.
6. Prior to use, install new O-Ring, apply silicone lubricant, and affix plunger to the STA drive unit.

### Installation of plunger and O-Ring assembly

Carefully slide O-Ring onto O-Ring groove at end of plunger. Screw the threaded end of the plunger into drive unit and rotate plunger clockwise until properly secured in drive unit. **Note: Apply a small amount of silicone lubricant to the O-Ring weekly or after every 24 cycles. Inspect O-Ring daily for signs of deterioration.**

### 4. Cartridge Breakage

Occasionally, a cartridge may break during insertion or operation. If a cartridge breaks it is important that all glass and fluid be removed from around the plunger and cartridge holder receptacle in the unit. Failure to remove glass particles can cause jamming and malfunction of the plunger. Any liquid spilt in the cartridge socket holder will be safely diverted out through the bottom of the unit.

If a cartridge breaks:

1. Remove cartridge holder and cartridge.
2. Turn unit over and remove any glass particles or fluid.
3. Using high volume suction, or compressed air, clean out cartridge holder receptacle on top of unit to remove fluid and glass particles.
4. Inspect for remaining glass particles and remove.
5. Remove plunger. Clean and autoclave the plunger before reuse. Discard O-Ring and replace with a new one.

**Warning: Door located on back of the unit is for certified personnel only. It should never be opened for any reason by unauthorized individuals.**



## **MAINTENANCE AND CARE**

### **STORAGE and HANDLING**

The STA drive unit should not be exposed to either excessive heat or cold. Place the STA unit where it will not be subject to falling or being pulled off the shelves. In addition, the STA unit should not be splashed with liquids.

- a. Operating and Storage High Temperatures (+40° C/+45° C, respectively)
- b. Operating and Storage Low Temperatures (+10° C/-20° C, respectively)
- c. Operating Humidity (30% to 70% non-condensing)

## TROUBLESHOOTING

<b>SYMPTOM</b>	<b>CAUSE</b>	<b>SOLUTION</b>
No power light	Switch is "OFF" No power at power outlet	Turn Switch to "On" Check fuse or circuit breaker
No aspirate light	Not in aspirate mode	Press reset once
When depressing foot control drive unit stops and/or warning light flashes	Computer malfunction  Improper installation of the plunger or O-ring  Dirty plunger  Blocked needle or cartridge	1. Press and hold aspirate button for 3 seconds.  2. Turn unit OFF, wait 15 seconds and restart.  3. Call Technical Service for assistance: 1.800.862.1125.  Install plunger or O-Ring properly  Remove, clean, lubricate and re-install plunger.  Replace needle and/or disposable
Drive unit does not respond to foot control activation	Foot control tubing is bent, pinched or blocked  Tubing not securely attached	Unblock foot control air hose.  Retighten air hose connection.
Anesthetic not flowing properly	Check for air gap between plunger and cartridge  Check for spike properly puncturing cartridge  Blocked needle or disposable	Replace cartridge  Push to puncture or replace handpiece assembly. See pg. 6 for proper puncture technique.  Replace needle and/or handpiece.
Aspiration inadequate	Worn or dry O-Ring	Replace or lubricate O-Ring

## TROUBLESHOOTING

SYMPTOM	CAUSE	SOLUTION
Cartridge is not pierced (does not fully seat into cartridge holder)	Inconsistent rubber diaphragm in cartridge	See pg. 6 for proper puncture technique.
Tabs break off cartridge during initial use	Not fully rotated into locked position	Make sure cartridge holder is twisted counter clockwise until it stops
Glass cartridge breakage	Cartridge installed at improper angle Cartridge not pierced Blocked needle or disposable	Always install cartridge in perpendicular position See pg 6 for proper puncture technique Replace needle and/or disposable

Announcements	Cause
"System Error" + 3 tones	Memory data corruption (Main code, Boot Loader, EEPROM read/write fail) or Power Supply Fault
"Plunger error" + 3 tones	Platform/motor failure (failed to home, stuck plunger). Used in manufacturing to indicate adjustment failure of platform
"Cartridge Error" + 3 tones	This alarm is active only if auto-cartridge is enabled. Indicates cartridge breakage/disconnect during plunger movement or cartridge attached while clean mode is activated.
"Overpressure" over tone or tone only	Occlusion of tubing or overpressure condition due to blocked needed. Stuck plunger.

## ADVANCED OPERATION

### DYNAMIC PRESSURE SENSING (DPS™) TECHNOLOGY

DPS technology is unique in that it allows a clinician to easily and accurately identify specific tissue types, at the needle position, based on tissue compliance. The ability to accurately identify specific tissue types based on real-time measurements of tissue resistance (i.e. tissue compliance, interstitial tissue pressure) is an important and critical aspect of using dynamic pressure sensing (DPS™) technology. Pressure measurement of different tissue-density type is related to the physical compliance of a specific tissue during fluid injection.

Dr. Mark Hochman introduced a fundamental change to drug delivery systems by developing dynamic pressure sensing (**DPS™**) technology with Milestone Scientific, Inc. thus enabling fluid-pressure and flow rate at the needle-tip to be precisely controlled and monitored in real-time during all phases of injection process. This pressure regulated computer-controlled local anesthetic delivery system (Pressure-CCLADS) represents a second generation device. Applying this new concept to dental injections enables the clinician to perform an easier, faster and more reliable dental injection technique. Importantly, it empowers the dentist to use the STA-Intraligamentary injection as a predictable primary injection technique.

The STA-System is the only computer-controlled dental local anesthetic delivery system in the world to provide real-time DPS™ technology. At the core of the STA-System lies an electro-mechanical motor regulated by a central microprocessor unit (CPU) functioning in concert with a force/pressure transducer. A series of force/pressure transducers detect system resistances, allowing a mathematical algorithm to calculate instantaneous real-time measurements of the fluid "exit pressure". The measured pressure data becomes a feedback signal which is then converted into an audible sound, as well as a visual display so that the user is continuously aware of the tissue density encountered. The concept of real-time dynamic pressure sensing and displaying is unique to this device and technology.

## ADVANCED OPERATION

### DYNAMICS OF THE INJECTION<sup>1</sup>

#### 1. COMPONENTS OF THE INJECTION

The STA System offers both physical and psychological advantages over conventional syringe technology. There are three (3) physical components to any injection which play a role in what the patient may experience during the injection process; 1. The initial penetration of the needle into tissue, 2. The advancement of the needle through the tissue and, 3. The deposition of anesthetic fluid in the tissue. The delicate pen-like STA Wand™ handpiece allows the operator to gently penetrate the mucosa and then direct the needle with unparalleled accuracy and precision. This promotes the accurate placement of the needle and deposition of anesthetic to achieve profound anesthesia. The psychological advantage of the STA Wand™ handpiece is that it does not resemble a syringe and is not threatening in appearance. If anticipatory anxiety is reduced and patient confidence is increased, the entire injection experience is likely to be a more positive one for the practitioner and the patient.

#### 2. MICROPROCESSOR CONTROLLED FLOW RATES

Many patients believe that the needle insertion is what causes discomfort when, in fact, most of the pain is caused by the flow of the anesthetic. When injected too quickly, traditional anesthetics create a burning sensation. Experts in anesthesia agree that a controlled *ControlFlo*™ rate of injection is ideal<sup>2</sup>. The STA unit, when set on the normal mode, uses *ControlFlo*™ and *RapidFlo*™, which automatically delivers optimal flow rates, regardless of tissue density. These patented controlled flow rates result in an injection experience that is typically below the threshold of pain.

#### 3. SLOW NEEDLE ADVANCEMENT CREATES ANESTHETIC PATHWAY

It is speculated that during needle insertion, a continuous positive solution pressure delivers an anesthetic drip that can precede the needle path. This anesthetic pathway is believed to assist in virtually eliminating discomfort as the needle penetrates through the tissue. STA injections often result in faster onset of anesthesia and a much more comfortable experience due to the anesthetic pathway. Advance the needle very slowly. To effectively create an anesthetic path it is necessary to pause (approx. 4 beeps) every 1 mm of advancement. The needle is advanced approximately 1 mm using active rotation, (see Rotation Needle Insertion, Section 4), pause for anesthetic flow, and then continue advancement. Rapid advancement of the needle will defeat the advantage of the anesthetic pathway.

---

<sup>1</sup> Hochman M., Friedman M. Technique Article: Injection Dynamics for a Comfortable Palatal Injection. In Review

<sup>2</sup> Malamed SF, Handbook of Local Anesthesia. Fourth Edition, Mosby, St. Louis, MO. ppg. 140-141

## ADVANCED OPERATION

### 4. Hand Control and Rotational Needle Insertion Methods

The most obvious difference between a syringe and the STA Wand™ handpiece is the delicate manner in which the STA Wand™ can be held and manipulated. Weighing only a few grams, the ultra-light handpiece promotes precise movements and unsurpassed tactile feedback. Unlike a syringe, the STA needle can be rotated between the thumb and forefingers, making possible new insertion methods. Always move the needle forward very slowly with the STA unit activated on the slow flow rate to generate an anesthetic pathway. There are three (3) distinct needle insertion methods:

- **Slight Rotation for insertion into mucosa**

Insert the needle with a deliberate rotation at the moment it enters the mucosa. This will enhance penetration by reducing the forward force necessary for puncturing the tissue. With a mono bevel needle, rotation brings the sharp needle surfaces into contact with a greater area of the tissue during the puncture and initial penetration. Once the needle is through the tissue surface, axial or bidirectional rotation can be performed to move the needle forward. Insure that all forward movement is slow while *ControlFlo*™ is activated.

- **Bidirectional rotation to prevent needle deflection (180°)**

In certain injections, such as the inferior alveolar block, accurate targeting is intimately related to clinical success. Needle insertion that penetrates greater than 10 mm can cause needle deflection regardless of needle gauge. This is due to the forces acting upon the mono-bevel needle. As the needle is advanced through the tissue, the tip is deflected. A bidirectional rotation of 180° in either direction will cancel deflection and should markedly increase accuracy. Bidirectional rotation (180° right and left) is performed by rotating the needle back and forth between the thumb and forefinger. The rotation is maintained along the axis of the needle path until the site is reached. Insure that the STA Wand™ handpiece is not bent or distorted because this will reduce the efficiency of rotation. The rotation movement itself should be performed at a rate of about one second in either direction. The operator will find that the rotational movement will also promote needle penetration without a conscious effort to move the needle forward. When mastered, this technique should greatly reduce anesthesia onset time and missed blocks.

- **Axial Rotation for insertion into palatal tissue (45°)<sup>1</sup>**

This needle movement has the effect of bringing the sharp edges of the mono bevel needle into contact with the entire penetration site. It is particularly effective in the dense connective tissue of the palate and should be used in conjunction with the pre-puncture technique described on page 34. Axial rotation (45° right and left) is performed by rotating the needle back and forth between the thumb and forefinger.

## ADVANCED OPERATION

The rotation is maintained along the axis of the needle path until bone is reached. Gently rotate the needle and move forward about 1 mm, stop for 4 seconds then proceed forward. This allows the anesthetic pathway to form. The rotation movement itself should be performed at a rate of about one second in either direction. The operator will find that the rotational movement will promote needle penetration without a conscious effort to move the needle forward.

### **SPECIAL NOTE ON NEEDLE DEFLECTION AND ROTATIONAL TECHNIQUE**

Needle deflection has long been recognized as altering the straight path of needle insertion. This can negatively impact the accuracy and predictability of the inferior alveolar block injection resulting in “missed blocks” and inadequate mandibular anesthesia. This may be due to the fact that, when using a traditional syringe, the insertion of the needle is linear, making it subject to deflection forces (Diagram A).

### **New Bidirectional Rotational Insertion**

Since the STA Wand™ disposable handpiece is held in a pen-like grasp, it can be rotated continuously during insertion. A recent investigation has demonstrated that a bidirectional rotational insertion technique (Diagram B) will alter the vector forces responsible for needle deflection, regardless of the needle gauge<sup>3</sup>. These findings have numerous clinical implications, the most obvious of which is accurate needle tracking to the target site.

### **Needle Rotation and Force Reduction**

Needle rotation also assists the cutting efficiency of the needle, helping to reduce the force needed to move the needle forward, so insertion is easier and smoother. In force tests using a digital scale, the force of the needle without rotation registers over 70 grams. With rotation of the needle, the force is dramatically reduced to just over 30 grams. This force reduction is very important in dense palatal tissue to achieve a comfortable injection. Also, with less force needed for penetration, the handpiece can be held with a light, delicate touch that maximizes tactile feel and control.

### **Benefits for the Practitioner**

Potential benefits of the technique include:

1. Fewer “missed” mandibular block injections<sup>3</sup>
2. Fewer re-injections of anesthetic.
3. More rapid onset of local anesthesia.
4. Reduced volume of anesthetic necessary to achieve anesthesia.
5. Reduced post-operative discomfort (e.g. trismus) from fewer injections

---

<sup>3</sup> In vitro study of needle deflection: A linear insertion technique versus a bidirectional rotation insertion technique; Hochman, Mark N., DDS; Friedman, Mark J., DDS; Quintessence Int. 2000:30:33-39

## ADVANCED OPERATION

### 5. Pre-Puncture Technique<sup>4</sup> for Palatal Injections

The palatal tissue is an area that requires careful attention to insure the most comfortable injection experience. The pre-puncture is a method that should significantly reduce the sensation of needle penetration. It relies on the torque of the STA motor to generate a high fluid pressure at low volume. This literally forces the anesthetic into the tissue prior to the actual needle penetration. The technique is as follows:

- Place the needle bevel against the palate, but do not puncture
- Place a sterile cotton tip applicator on the back of the bevel and apply and apply pressure (a).
- Activate the STA unit on *ControlFlo*<sup>TM</sup> for 8 - 10 beeps to force anesthetic into the tissue
- Continue to apply pressure from the applicator and slowly start bi-axial rotation
- The pressure from the cotton tip applicator is used to deliver pressure anesthesia
- Continue axial rotation for 2 beeps moving forward 1-2 mm, followed by a brief pause for 4 beeps (b)
- Repeat previous step of rotation, forward movement, pause, until contact with bone is made.
- Once bone is reached stop axial rotation, but continue the *ControlFlo*<sup>TM</sup> flow rate
- Use the cotton tip applicator to catch drips as needle is withdrawn

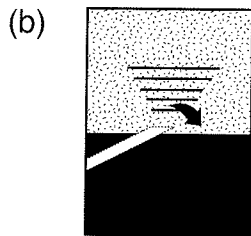
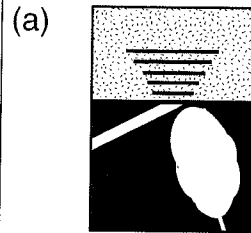

<sup>4</sup> Hochman M, Friedman M. Technique Article: Injection Dynamics For a Comfortable Palatal Injection. Manuscript in Review



## ADVANCED OPERATION

### 6. New Injection Dynamics with the STA System

Timing the exact moment that a drop of anesthetic is going to be expressed from the STA Wand™ handpiece takes some practice. It is recommended that a cotton tip applicator be placed close to the site of injection to absorb any anesthetic solution which is expressed from the needle prior to penetration into the tissue and when the needle is removed from the tissue.

The *ControlFlo*™ (slow) rate is used during the initial stage of all injections. Maintaining the *ControlFlo*™ anesthetic drip during careful, slow penetration of the needle helps to create an anesthetic path within the tissue. This should be done even if penetration is only a few millimeters. In denser tissues such as the palate or periodontal ligament space, the *ControlFlo*™ rate of injection should be maintained through the entire injection process. Other injections such as the inferior alveolar nerve block or maxillary mucobuccal fold infiltration are initiated with a slow penetration and *ControlFlo*™ rate. Once the needle reaches the target landmark, aspiration is initiated and if negative, the faster *RapidFlo*™ or *TurboFlo*™ rate of injection can be employed. Aspiration can be repeated at any time during the injection by releasing pressure from the foot control.

## CLINICAL TECHNIQUES

The STA System is capable of performing all the traditional injections that are routinely performed to achieve effective local anesthesia in dentistry. The distinction is that these dental injections can now be performed more comfortably and easier for both the patient as well as the operator when administered with the STA-System.

The STA System enables you to perform several new dental injection techniques that were developed in conjunction with this technology. The AMSA, P-ASA and STA-Intraligamentary injections are unique dental injections in that they require precise flow-rates and pressure to safely and properly perform these injections. Each of these injections can be used effectively as primary dental injection when treating your patients.

## CLINICAL TECHNIQUES STA Intraligamentary

The STA-Intraligamentary injection represents an effective primary dental injection for single tooth anesthesia. It provides a level of safety, comfort and effectiveness previously unattainable. The STA-Intraligamentary injection and STA-System offers the clinician three distinct benefits that cannot be achieved using the standard dental syringe, the pistol-grip high-pressure syringe, or other CCLADS systems:

1. An objective means to determine tissue compliance and thereby determine the tissue type into which the needle is inserted.
2. Objective, continuous, real-time pressure feedback data ensuring that the prescribed moderate pressure range is maintained within the injected tissues.
3. Objective, real-time information as to the occlusion of a needle and/or the loss of pressure resulting from intra-oral anesthetic solution leakage.

The STA-System with DPS technology is the only computer-controlled local anesthetic delivery system with the ability to provide important clinical feedback in a real-time fashion, thus allowing adjustments and confirmations to be made as determined by the clinician. This sophisticated technology simplifies the process of the intraligamentary injection by providing clinicians with a new, interactive injection system.

### **Review of the STA-Intraligamentary Injection Technique:**

1. Verify the unit is set to "STA-Mode"
2. Perform the aspiration pre-test (as described in the instructions).
3. Initiate the *ControlFlo*<sup>TM</sup> flow rate, note that after approximately 3 seconds you will hear the word "CRUISE" spoken. You may elect to use cruise-control.
4. Gently and slowly advance the needle within the sulcus, as if it was a periodontal probe. Begin injection at distal site followed by mesial.
5. Use a finger-rest to control the movement to carefully control and stabilize all needle movements.
6. As the needle is introduced through the tissues, the STA-System provides continuous audible and visual feedback to assist the clinician.
7. As the pressure increases the visual pressure sensing scale (i.e. gauge) on the front of the unit the L.E.D. lights will change from – orange to yellow to green.
8. As the pressure increases the auditory feedback comprised of a series of ascending tones will be heard.

**NOTE:** It is not unusually to have to reposition the needle multiple times to identify the optimal needle-to-ligament position. This "searching" is guided by real-time dynamic pressure sensing feedback and is what allows a clinician to develop a high degree of predictability and accuracy when performing this injection.

## CLINICAL TECHNIQUES STA Intraligamentary

9. Once the optimal position within the intraligamentary tissue has been identified the clinician will initially hear the letters "PDL" spoken followed by a repeated tone, indicating that the correct needle position has been achieved. In addition, the visual pressure sensing scale will illuminate the green LED's.
10. The user should deposit the appropriate amount of anesthetic solution once positioned within the intraligamentary tissues.

**NOTE:** An "over-pressure" condition is when pressures exceed the maximum pressure programmed in the unit. The STA drive unit will sound an auditory and visual alert and the unit will stop. The clinician can then restart the injection. It might be necessary to re-position or move the needle to a new location. **It is not uncommon for an over-pressure condition to occur, this emphasizes an importance of being able to monitor real-time pressure with DPS technology.**

### Drug Selection:

The clinician should use his/her own judgment as to the anesthetic drug selection and volumes used. The following information serves only as a guideline, and clinicians are advised to refer to the appropriate drug manufacturers for specific recommendations. In addition, clinicians are advised to review the current dental literature and dental textbooks for guidance on recommended dosages and drug recommendations.

When using 2% Xylocaine Hydrochloride 1:100,000 Epinephrine or other local anesthetics formulated with a 2% concentration the following recommendations are made:

- A drug volume of 0.9 ml is recommended for single rooted teeth.
- A drug volume of 1.8 ml is recommended for multi-rooted teeth.

When using 4% Articaine Hydrochloride or other local anesthetics formulated with a 4% concentration the following recommendations are made. **NOTE:** it is recommended when using 4% Articaine hydrochloride that only a 1:200,000 vasoconstrictor concentration be used:

- A drug volume of 0.5 ml is recommended for single rooted teeth.
- A drug volume of 0.9 ml is recommended for multi-rooted teeth.
- The use of 2% local anesthetics containing a vasoconstrictor concentration of 1:50,000 parts is not recommended for administration of an intraligamentary injection.
- The use of 4% local anesthetics containing a vasoconstrictor concentration of 1:100,000 parts is not recommended for administration of an intraligamentary injection and palatal injections (i.e. AMSA and P-ASA).

## CLINICAL TECHNIQUES STA Intraligamentary

### **STA-Intraligamentary indications and contraindications:**

The indicated use of the STA-Intraligamentary injection is as a primary injection for patients receiving dental care. A thorough medical history and dental history should be routinely taken on all patients. Patients should be in general good health. The clinicians are advised to rely on their own judgment and refer to standard dental anesthesia textbooks for accepted standards of care regarding this subject matter.

**Contra-indication:** Intraligamentary injections are contraindicated in patients with active periodontal disease.

**NOTE:** It is important to note that multiple clinical studies have been published and presented using computer-controlled local anesthesia systems for pediatric patients. The scientific data supports and encourages the use of this device to perform the intraligamentary injection specifically for the pediatric patient.

1. Allen KD, Larzelere RE, Hutfless S, Beiraghi S. Comparison of a computerized anesthesia device with a traditional syringe in preschool children. *Pediatr Dent*. 2002;24:315-320.
2. Ram D, Peretz B. Assessing the pain reaction of children receiving periodontal ligament anesthesia using a computerized device (Wand). *J Clin Pediatr Dent*. 2003;27:247-250.
3. Ashkenazi M, Blumer S, Ilana E. Effectiveness of computerized delivery of intrasulcular anesthetic in primary molars. *JADA*. 2005;136:1418-1425.
4. Versloot J, Veerkamp JSJ, Hoogstraten J. Computerized anesthesia delivery system vs. traditional syringe: comparing pain and pain-related behavior in children. *Eur J Oral Sci*. 2005;113:488-493.
5. Öztas N, Ulusu T, Bodur H, Dogan C. The Wand in pulp therapy : An alternative to inferior alveolar nerve block. *Quint. International*. 2005;36:(7)559-564.
6. Nicholson JW, Berry TG, Summitt JB, Yuan CH, Witten TM. Pain perception and utility: A comparison of the syringe and computerized local injection techniques. *Gen Dent*. 2001;167-172.

## CLINICAL TECHNIQUES AMSA

### Anterior Middle Superior Alveolar (AMSA) Injection Technique<sup>5</sup>

The AMSA is an exciting addition to local anesthesia techniques. It will allow the operator to achieve pulpal anesthesia from the maxillary central incisor through the second premolar including the palatal tissue and mucoperiosteum from a single needle penetration. The recommended dosage is from 3/4 to 1 cartridge of anesthetic and the expected duration of anesthesia is approximately 60 minutes. A bilateral AMSA anesthetizes 10 maxillary teeth extending from the second premolar to the opposite second premolar and the associated palatal tissue from just 1 1/2 to 2 cartridges of anesthetic. The lips, face and muscles of expression are not anesthetized with the AMSA resulting in greater patient comfort operatively and post operatively. In addition, esthetic smile-line assessments are not hampered by facial distortion associated with traditional mucobuccal fold injections. To enhance buccal soft tissue anesthesia a small volume of anesthetic is administered at the mucuccal gingival junction.

The AMSA is easily administered, requiring up to 4 minutes to complete. Anesthesia is achieved within approximately 5 - 7 minutes of injection. The patient should be prepared for the extra time required to administer an AMSA and advised they will likely experience only a minor sensation from the injection. They will appreciate the lack of numbness to the face and lips.

A 30 gauge extra-short needle is recommended. It is inserted in a position that bisects the premolars and is approximately halfway between the mid-palatine suture and the free gingival margin. On patients with either a flat or excessively high palatal vault, the landmark is adjusted closer to the mid-line. If desired, topical anesthetic may be applied. The needle bevel is initially oriented parallel to the palatal tissue. A sterile cotton tip applicator is employed to apply pressure on the needle to "seal" the bevel to the tissue for the "pre-puncture" phase of the insertion. (see pre-puncture section) The foot control is depressed slightly to activate the *ControlFlo*<sup>TM</sup> flow rate for 8 - 10beeps prior to slow needle insertion. The cotton tip will help catch any anesthetic drips that occur before the bevel is completely within the tissue. The needle movements are extremely slow and gentle during penetration while the *ControlFlo*<sup>TM</sup> flow rate is maintained. The needle is reoriented to a 45° angle as it is advanced until it contacts the bone.

---

<sup>5</sup> The AMSA injection: A new concept for local anesthesia of maxillary teeth using a computer-controlled injection system; Friedman, Mark J., DDS; Hochman, Mark N., DDS; Quintessence Int. 1998: 29:297-303.

## CLINICAL TECHNIQUES AMSA

Perform aspiration. Maintain contact on bone and deliver the required dosage of 3/4 to 1 cartridge. Significant blanching of the palate will be observed (with anesthetics containing vasopressor) and care should be taken upon needle removal to reduce anesthetic solution from dripping down the posterior palate.

**Note: It is critical that only the *ControlFlo*™ rate be used for this injection.** Using the fast rate of flow may cause excessive ischemia and tissue damage. It is recommended that anesthetic containing vasopressor concentration of 1:100,000 or 1:200,000 be used. Caution should be exercised with 1:50,000 concentration of vasopressor. Excessive ischemia can result in soft tissue damage.

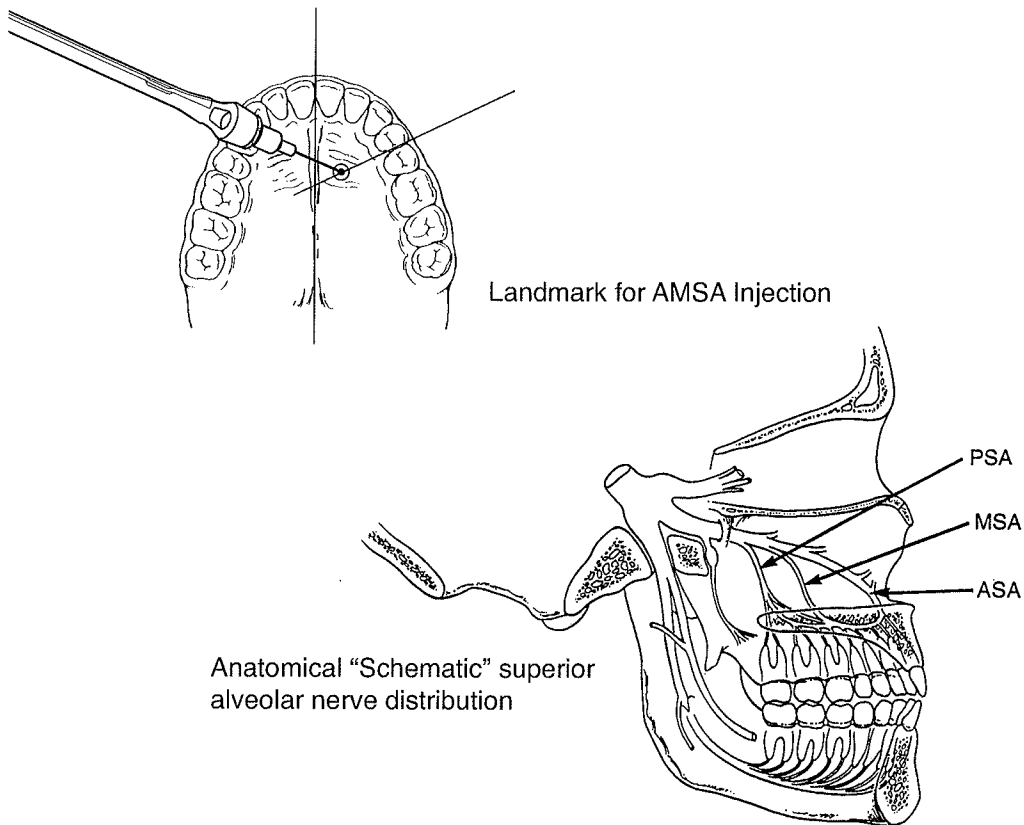

## CLINICAL TECHNIQUES AMSA

### REVIEW OF THE AMSA INJECTION TECHNIQUE

1. Prepare the patient for a longer injection experience.
2. Place topical anesthetic on the palatal tissue if desired.
3. Orient a 30 gauge extra-short needle, bevel parallel to the palatal tissue at the landmark which bisects the premolars and is midway between the free gingival margin and the mid palatine suture.
4. Place a sterile cotton tip applicator to absorb any anesthetic drip prior to needle penetration.
5. Perform pre-puncture technique.
6. Rotate needle slightly upon entering tissue and during movement to final site.
7. Initiate the ControlFlo flow rate at the moment that the needle enters the palatal tissue and maintain this rate continuously. Reorient needle to 45° and advance the needle very slowly until it contacts bone.
8. Perform aspiration.
9. Cruise control can be activated if desired.
10. Continue to inject until approx. 3/4 to 1 full cartridge (if using 2% concentration) has been deposited.
11. Remove the needle slowly and try to avoid any excess anesthetic dripping.
12. Repeat on the contralateral side if required.



## CLINICAL TECHNIQUES P-ASA

### **The Palatal Anterior Superior Alveolar (P-ASA)<sup>6</sup>**

The P-ASA is another modified injection for the anterior maxilla. It will allow the operator to achieve bilateral anesthesia of the maxillary incisors and usually the canines from a single needle penetration. In addition to pulpal anesthesia, profound palatal anesthesia of the gingiva and mucoperiosteum as well as moderate anesthesia of the facial gingiva associated with the teeth is achieved. The recommended dosage is from 3/4 to 1 cartridge of anesthetic (if using 2%) with the expected duration of anesthesia of approximately 60 - 90 minutes. Of significant benefit is that the lips, face and muscles of expression are not anesthetized with the P-ASA. This results in greater patient comfort operatively and post operatively. In addition, esthetic smile-line assessments are not hampered by facial distortion associated with traditional mucobuccal fold injections in this region.

The P-ASA is easily administered, requiring from 2 - 4 minutes to complete. Anesthesia is achieved within approximately 2 minutes of injection. The patient should be prepared for the extra time required to administer the P-ASA and advised they will likely experience only a minor sensation during the injection. They will appreciate the lack of numbness to the face and lips.

A 30 gauge extra-short needle is recommended. It is inserted adjacent to the incisive papilla. If desired, topical anesthetic may be applied. The needle bevel is initially oriented as parallel to the palatal tissue as possible. A sterile cotton tip applicator is employed to apply pressure on the needle to "seal" the bevel to the tissue for the "pre-puncture" phase of the insertion. (see pre-puncture section) The foot control is depressed slightly to activate the *ControlFlo* flow rate for 8 - 10 beeps prior to slow needle insertion. The cotton tip will help catch any anesthetic drips that occur before the bevel is completely within the tissue. The needle movements are extremely slow and gentle during penetration while the *ControlFlo* flow rate is maintained. After penetration into the papilla, insertion is continued until significant blanching of the papilla is observed. The needle is then reoriented to gain entrance into the nasopalatine canal and advanced very slowly no more than 1 cm (approximately the depth of a 1/2" needle). Maintain contact on bony wall of the canal and then aspirate. Deliver the required dosage of 3/4 to 1<sup>7</sup> cartridge. Significant blanching of the palate tissue and often the facial tissue will be observed (with anesthetics containing vasopressor). Care should be taken upon needle removal to reduce anesthetic solution dripping down the palate. Do not advance the needle beyond 1/2" (1 cm) since the floor of the nose can be penetrated which may lead to an infection.

---

<sup>6</sup> Friedman MJ, Hochman MN. P-ASA Block Injection: A New Palatal Technique to Anesthetize Maxillary Anterior Teeth, *Journal of Esthetic Dentistry*, 1999, Vol. 11, Number 2.

<sup>7</sup> Dosage requirement for adequate anesthesia and duration may vary from one patient to another.

## CLINICAL TECHNIQUES P-ASA

**Note: It is critical that only the *ControlFlo*™ rate be used for this injection.** Using the fast rate of flow may cause excessive ischemia and tissue damage. It is recommended that anesthetic containing vasopressor concentration of 1:100,000 or 1:200,000 are used. Caution should be exercised with 1:50,000 concentration of vasopressor. Excessive ischemia can result in soft tissue damage.

Figure 15

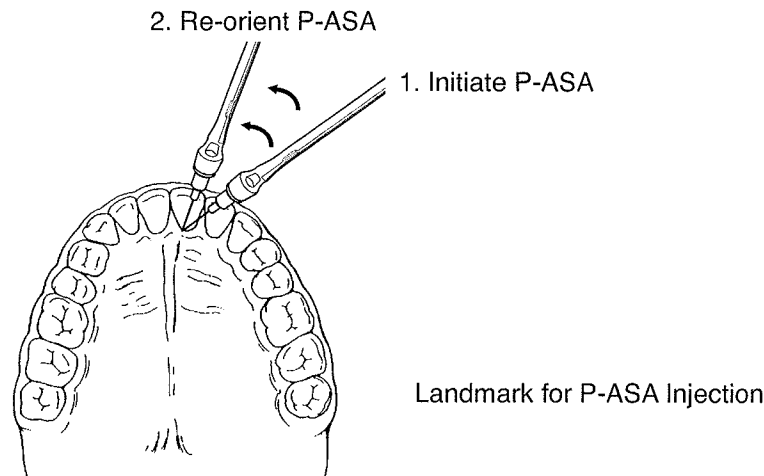

### REVIEW OF THE P-ASA INJECTION TECHNIQUE

1. Prepare the patient for a long injection experience.
2. Place topical anesthetic on the incisive papilla if desired.
3. Orient a 30 gauge extra-short needle in the groove just lateral to the incisive papilla.
4. Use a sterile cotton tip applicator for the pre-puncture technique.
5. Initiate the *ControlFlo* flow rate and maintain this rate throughout the injection.
6. After 8 - 10 beeps initiate axial rotation and VERY SLOW forward movement but continue *ControlFlo* flow rate.
7. Once the needle bevel enters below the papilla, pause movement for 5 - 6 seconds.
8. After papilla is blanched, re-orient the needle vertically to gain entrance to the nasopalatine canal with slow axial rotation.
9. When the needle is in the canal and contacting the inner bony wall, stop movement and aspirate. DO NOT EXCEED 1 cm (length of 1/2" needle) penetration into the canal.
10. If aspiration is negative, maintain position and deliver 3/4-1 cartridge of anesthetic (If using 2% solution) at the *ControlFlo* rate.
11. Cruise control can be activated if desired.
12. Remove needle slowly to avoid excess dripping into the mouth.

## CLINICAL TECHNIQUES TRADITIONAL

### Traditional Infiltration Technique

The STA drive unit and the STA Wand™ handpiece are ideally suited for the administration of traditional injections. A **Maxillary Mucobuccal Fold** infiltration is initiated with the *ControlFlo*™ rate – first position on the foot control. The needle is advanced slowly until it reaches the intended target site. Aspiration is initiated if required (release foot control pressure) and, if negative, the *RapidFlo*™ rate (second foot control position) can be initiated. A **Posterior Superior Alveolar Block** injection (PSA) can be performed in a similar manner. Palatal infiltration can also be performed consistently and comfortably with the STA System. However, it is critical that the *ControlFlo* flow rate be used exclusively. **Never use the *RapidFlo*™ or *TurboFlo*™ rate for palatal injections.**

#### Review of Traditional Maxillary Mucobuccal Fold Infiltration Technique:

1. Perform an aspiration pre-test (as described in the instructions).
2. Initiate the *ControlFlo*™ (first foot control position) flow rate.
3. Slight needle rotation at the moment of mucosa puncture facilitates penetration of the surface tissue.
4. Penetrate mucosa with a slow, gentle advancement of the needle to create an “anesthetic pathway”.
5. When the needle reaches the target site, aspiration can be initiated if required (release foot control). If using Cruise Control, tap the foot control to aspirate.
6. Aspiration is repeated until negative aspiration is observed.
7. When aspiration is negative, initiate the *RapidFlo*™ (second foot control position) flow rate.
8. Monitor the LED panel to determine the volume of anesthetic delivered.
9. When the cartridge is emptied (audio and visual signal), reload, purge and continue as required.

## CLINICAL TECHNIQUES INFERIOR ALVEOLAR

### Inferior Alveolar (Mandibular) Nerve Block

The most common approach to mandibular anesthesia is the Inferior Alveolar Nerve Block injection. The STA Wand™ handpiece enables the operator to concentrate on accurate needle placement and provides unprecedented control and tactile feel during this injection. The rotational insertion technique described earlier reduces needle deflection and missed blocks and facilitates more rapid onset of anesthesia.

The aspiration mode should be enabled prior to initiating the injection. Topical anesthetic can be applied to the intended injection site. However, it may not be required to achieve a comfortable penetration. *ControlFlo*™ is initiated prior to needle penetration of the mucosa. Rotate the STA Wand™ handpiece slightly at the commencement of the injection to reduce pressure required for needle penetration. Advance the needle slowly using a continuous rotation technique to reduce needle deflection to the intended target site. Initiate aspiration by releasing the foot control. If using Cruise Control, tap the foot control to aspirate. If positive, reposition the needle and resume the *ControlFlo* flow rate and repeat aspiration. If aspiration is negative either *RapidFlo*™ or *TurboFlo*™ rates can be initiated. For buccal anesthesia of the soft tissue and periosteum of the mandibular molars, administer a long buccal nerve block. Other mandibular injections can be performed in a similar manner (Mental, Incisive, Gow Gates, Vazirani-Akinosi and Long Buccal.)

#### Review of Traditional Inferior Alveolar (Mandibular) Block Technique:

1. Perform an aspiration pretest (as described earlier).
2. Initiate the *ControlFlo*™ (first foot control position) flow rate.
3. Penetrate the mucosa with a slow, gentle advancement of the needle to create an “anesthetic pathway”.
4. Slight needle rotation at the moment of mucosa puncture facilitates penetration.
5. Use needle rotation technique during entire insertion to reduce needle deflection.
6. When the needle reaches the target site, aspiration is initiated (release foot control or tap foot control if using Cruise Control).
7. If blood is observed in handpiece tubing, reposition and repeat aspiration
8. When aspiration is negative, initiate the *RapidFlo*™ (second foot control position) flow rate.
9. Monitor the LED panel to determine the volume of anesthetic delivered
10. When the cartridge is emptied (indicated by audio and visual signals), reload, purge and continue as required.

All traditional injections in the maxilla and the mandible are performed following the steps outlined above. When not required, the aspiration mode can be disabled by briefly depressing the aspirate mode button. Light will turn off.

## ADDITIONAL INFORMATION

### Warranty Information

#### **FOR INTERNATIONAL WARRANTY CONSULT YOUR LOCAL DISTRIBUTOR**

STA Computer Controlled Local Anesthetic Delivery System Limited Warranty  
United States

The STA System is warranted for a period of one year from date of purchase against manufacturing defects in materials and workmanship, and any claims under this warranty must be made and received before the end of such one year period. Repairs or replacement will be made by Milestone Scientific or its authorized agents at the sole discretion of Milestone Scientific. This warranty shall be limited to replacement or repair of the unit or its parts and shall not include any other claims, including but not limited to loss of profit, cost of removal or replacement or special, incidental, or consequential damages or other similar claims arising from the use of this product.

Damages to the product resulting from acts of God, faulty installation, misuse, tampering, accident, abuse, negligence, or unauthorized repairs or alterations unrelated to problems with materials and workmanship are not covered by this warranty.

**Milestone Scientific specifically disclaims all other warranties, expressed or implied, including but not limited to any implied warranty of merchantability or fitness for a particular purpose.**

This warranty gives you specific legal rights, and you may have other rights which may vary from state to state.

### WARRANTY SERVICE

Warranty service is to be handled through Milestone Scientific. If you are experiencing a problem, please call Milestone Scientific for technical support prior to returning the unit. When returning please provide adequate and protective packaging. Include your name, address, phone number and a thorough description of the operating problem. After repairing or replacing this product Milestone Scientific will return it directly to you.

## ADDITIONAL INFORMATION

### Power Requirements

- a. 110 – 120 VAC 50/60 Hz, .3A
  - i. Korea: 100-110V 50/60Hz. .3A
- b. 200-240 VAC 50/60 Hz, .15A
  - i. Australia: 200-230V 50/60 Hz, .15A
  - ii. Korea: 200-220V 50/60 Hz, .15A

### Fuse Replacement

Figure 16 Fuse Replacement Illustration

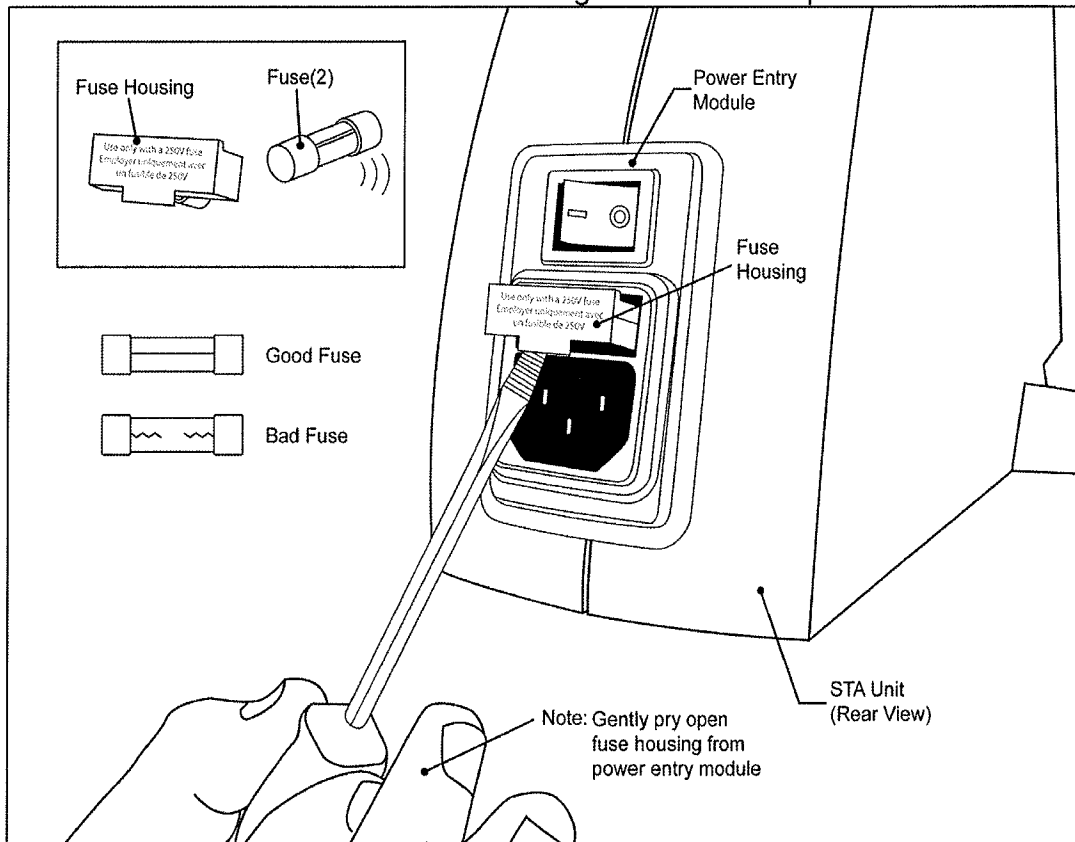

The procedure below is to be followed when fuse replacement is required. Warning: remove all power to the STA unit before proceeding.

1. Unplug and remove all power from the STA unit
2. Carefully pry open the fuse housing from the power entry module as shown in the figure above.
3. Remove both fuses and evaluate them. If the fuses are determined to be “Bad” then replace them with a next to the power entry module located on the back of the unit.
4. Carefully, replace fuse housing and snap into power entry module.

# ADDITIONAL INFORMATION

## Product Safety Information

The following is a brief description of the classifications which apply to this unit including a detailed explanation of the nameplate label.



ADDITIONAL INFORMATION

### Product Safety Information



The following is a brief description of the classifications which apply to this unit including a detailed explanation of the nameplate label.

**NAMEPLATE LABEL:**

Milestone Scientific  
Livingston, NJ 07039 USA  
CompuDent STA  
Ref: STA-S110  
Rx Only  
DENTAL PRODUCT

WITH RESPECT TO ELECTRIC SHOCK, FIRE AND MECHANICAL HAZARDS ONLY IN ACCORDANCE WITH IEC 60601-1, IEC 60601-1-1, IEC 601-1-2, CAN/CSA C22.2 No. 601.1.







SN A0644018000



U.S. Pat. #5,180,371  
U.S. Pat. #6,022,337  
U.S. Pat. #6,200,289  
U.S. Pat. #6,652,482  
U.S. Pat. #6,786,885  
U.S. Pat. Appl. #10,827,969

E-REP PDST Ltd.  
Blocity Nottingham  
Pennyfoot Street  
Nottingham, U.K. NG1 1GF  
0044-(0)115-912-4277

MFR: TRICO Systems Inc. Made in the U.S.A.

	Indicates CE Classification
	Indicates UL Classification
	Identifies fuse location and type
	Attention, consult ACCOMPANYING DOCUMENTS
	Symbol indicating disposal of this product should be in accordance with WEEE Directive 1999/31/EC
	Indicates CE Classification

This unit is considered a "continuous use" device and was tested in a worst case situation. 'Worst case' was defined as dispensing 10 consecutive cartridges of anesthetic with only the minimal amount of time required to replace each cartridge. In normal use the rate of dispensing cartridges should not exceed this limit without allowing the unit to stand idle for a minimum of 15 minutes.

## ADDITIONAL INFORMATION

This unit is defined as a Class IIA device per Rule 11 of the Medical Directive. The enclosure is suitable for an ordinary location. The function of this unit defines it as Type B. This equipment is not suitable for use in the presence of a flammable anesthetic mixture with air or oxygen or nitrous oxide. This unit is a Class 1 earthed device.

NOTE: This equipment has been tested and found to comply with the limits for a Class B digital device, pursuant to Part 15 of the FCC Rules. These limits are designed to provide reasonable protection against harmful interference in a residential situation. This equipment generates uses and can radiate radio frequency energy and, if not installed and used in accordance with the instructions, may cause harmful interference to radio communications. However, there is no guarantee that interference will not occur in a particular installation. If this equipment does cause harmful interference to radio or television reception which can be determined by turning the equipment off and on, the user is encouraged to try to correct the interference by one or more of the following measures:

- Reorient or relocate the receiving antenna
- Increase the separation between the equipment and receiver.
- Connect the equipment into an outlet on a circuit different from that to which the receiver is connected.
- Consult the dealer or an experienced radio/TV technician for help.



## ADDITIONAL INFORMATION

### Source for Further Reading

#### Computer Controlled Local Anesthesia Delivery System References

1. Hochman MN, Chiarello D, Hochman CB, Lopatkin R, Pergola S. Computerized Local Anesthesia Delivery vs. Traditional Syringe Technique. *NY State Dent J.* 1997;63:24-29.
2. Friedman MJ, Hochman MN. 21<sup>st</sup> Century Computerized Injection for Local Pain Control. *Compend Contin Educ Dent.* 1997;18:995-1003.
3. Krochak M, Friedman N. Using a precision-metered injection system to minimize dental injection anxiety. 1998;19(2):137-148.
4. Friedman MJ, Hochman MN. The AMSA injection: A new concept for local anesthesia of maxillary teeth using a computer-controlled injection system. *Quintessence Int.* 1998; 29:297-303.
5. Farah JW. Editors Choice-The Wand. *The Dental Advisor.* 1998;15:1.
6. CRA. Local Anesthesia, Automated Delivery. *Clinical Research Associates Newsltr.* 1998;22:1-2.
7. Friedman MJ, Hochman MN. P-ASA Block Injection: A new palatal technique to anesthetize maxillary anterior teeth. *J Esthet Dent.* 1999;11(2):63-71.
8. Gardner M. The AMSA Block: It will leave your patients smiling. *Oral Health.* 1999;July:43.
9. Leiberman, William H. Clinical Session:The Wand. *Pediatric Dent.* 1999;21:2.
10. Levato C. Giving the Wand a shot. *Dent Pract Fin.* 1998;July:53.
11. Kehoe B. In search of the painless injection. *Dent Pract Fin.* 1998;July:53.
12. Lackey A. Technology:An advancement in the delivery of local anesthesia. *Pract Perio Aesthet Dent.* 1998;10:1191-1193.
13. Asarch T, Allen K, Petersen B, Beiraghi S. Efficacy of a computerized local anesthesia device in pediatric dentistry. 1999;21:421-424.

14. Oldak S, Jackson LA. As we see it: The Wand. *J Southeast Soc Pediat Dent.* 1999;5:38.
15. Kronish E. Creating a less painful image of dentist. *AGD Impact.* 1999;April
16. Hochman MN, Friedman MJ. In vitro study of needle deflection: A linear insertion technique versus a bi-directional rotation insertion technique. *Quintessence Int.* 2000;31:737-743.
17. Gibson RS, Allen K, Hutfless S, Beiraghi S. The Wand vs. traditional injection: A comparison of pain related behaviors. *Pediatric Dent.* 2000;22:458-462.
18. Froum SJ, Tarnow D, Caiazzo A, Hochman MN. Histologic response to intraligament injections using a computerized local anesthetic delivery system. A pilot study in Mini-Swine. *J Periodontol.* 2000;71:1453-59.
19. Lipton L. Using Computer-controlled technology to alleviate stress & reduce discomfort during local anesthetic delivery in a pediatric practice. *J Southeastern Soc Pediatric Dent.* 2000;6:22-32
20. Goodell GG, Gallagher FJ, Nicol BK. Comparison of a controlled injection pressure system with a conventional technique. *Oral Surg Oral med Oral Pathol Oral Radiol Endod.* 2000;90:88-94.
21. Friedman MJ, Donaldson D, Malamed SF, Yagiela JA. Technology Forum: New Advances in Local Anesthesia. *Compend Contin Educ Dent.* 2000;21:432-440.
22. Grace EG, Barnes DM, Macek MD. Patient and dentist satisfaction with a computerized local anesthetic injection system. *Compend Contin Educ Dent.* 2000;21:746-752.
23. Aboushala A, Kugel G, Efthimiadis N, Korchak M. Efficacy of a computer-controlled injection system of local anesthesia in vivo. *IADR Abstract.* 2000;Abst#2775.
24. Cheng H, Pong PY, Chang WJ, Lee SY. Using a computer-controlled injection system to minimize dental injection pain. *IADR Abstract.* 2000;Abst#2777.
25. Loomer PM, Perry DA. Efficacy of computer-controlled local anesthesia during scaling and root planing. *IADR Abstract.* 2000;Abst#590.
26. Koili K, Boyles J, Gavlak J, Weaden S, Crout R. Comparing the efficacy of the Wand and traditional buccal infiltrations. *IADR Abstract.* 2000;Abst#2772.
27. Nicholson JW, Berry TG, Summitt JB, Yuan CH, Witten TM. Pain perception and utility: A comparison of the syringe and computerized local injection techniques. *Gen Dent.* 2001;167-172.

28. Jackman DS, Hertz MB. Techniques of Drug Administration. *Oral Maxillo Surg Clinics North Amer.* 2001;13:199-213.
29. Friedman MJ, Hochman MN. Using AMSA and P-ASA nerve blocks for esthetic restorative dentistry. *Gen Dent.* 2001;49(5):506-511.
30. Hochman MN, Friedman MJ. An in vitro study of needle force penetration comparing a standard linear insertion to the new bidirectional rotation insertion technique. *Quintessence Int.* 2001;32:789-796.
31. Fukayama H. New Trends in Local Anesthesia. *Hyogo Dental Assoc J.* 2001;Jan;593-602.
32. Tan PY, Vukasin P, Chin ID, Ciona CJ, Ortega AE, Anthonie GJ, Corman ML, Beart RW. The Wand local anesthetic delivery system. *Diseases Colon Rectum.* 2001;44:686-689.
33. Landsman A, DeFronzo D, Hedman J, McDonald J. A new system for decreasing the level of injection pain associated with local anesthesia of a toe. *Am Acad Podiat Med.* 2001;Abstract.
34. Barusco MN, Leavitt ML. The use of computerized anesthesia injection system to minimize pain during hair transplant surgery. *Hair Transplant Forum Inter.* 2001;11:107-108.
35. Isen D. A review of computer controlled injection devices. *Oral Health.* 2001 July:31-34.
36. Kudo M, Ohke H, Katagiri K, Sato Y, Kawai T, Kato M, Kokubu M, Shinya N. The shape of local anesthetic injection syringes with less discomfort and anxiety- Evaluation of discomfort and anxiety caused by various types of local anesthetic injection syringes in high level trait-anxiety people. *J Japan Dent Soc Anesthesiol.* 2001;29:173-178.
37. Rosenberg E. A computer-controlled anesthetic delivery system in a periodontal practice: Patient satisfaction and acceptance. *J Esthet Restor Dent.* 2001;13:25-32.
38. Allen KD, Kotil D, Larzelere RE, Hutfless S, Beiraghi S. Comparison of a computerized anesthesia device with a traditional syringe in preschool children. *Pediatr Dent.* 2002 Jul-Aug;24(4):315-20.
39. True RH, Elliot RM. Microprocessor-controlled local anesthesia versus the conventional syringe technique in hair transplantation. *Dermatol Surg.* 2002;28:64-69.

40. Swanepoel PF, Heystek P. Computer assisted local anesthetic application for nasal surgery. 8<sup>th</sup> AAFPRS Inter. Sympos. 2002;Abstract.
41. JADA. Dental Product Spotlight:Local anesthetic delivery. JADA 2002;133(JADA's 1<sup>st</sup> product review);106.
42. Blanton PL, Jeske AH. Dental Local Anesthetics: Alternative Delivery Methods. 2003;134:228-234.
43. Perry DA, Loomer PM. Maximizing Pain Control. The AMSA Injection can provide anesthesia with few injections and less pain. Dimensions of Dental Hygiene 2003;April/May:28-33.
44. Ram D, Peretz B .J Clin Pediatr Dent. 2003 Spring;27(3):247-50.Assessing the pain reaction of children receiving periodontal ligament anesthesia using a computerized device (Wand).
45. Fukayama H, Yoshikawa F, Kohase H, Umino M, Suzuki N. Efficacy of AMSA anesthesia using a new injection system, the Wand. Quintessence International, 2003;34:537-541.
46. Peter M. Loomer & Dorothy A. Perry, Comparison of Computer-Controlled Delivery to Syringe Delivery of Local Anesthetic During Therapeutic Scaling and Root Planing. JADA 2004;135:358-365.
47. Kasaj A, Berakdar M, Nicolaescu A, Willershausen, Sculean A. Evaluation of a new anesthesia technique for nonsurgical periodontal therapy. Johannes Gutenberg-University, Mainz, Germany. IADR/AADR/CADR 82nd General Session (March 10-13, 2004) Abstract #222 - Anesthesiology Research 2
48. Schwartz-Arad D, Dolev E, Williams W. Maxillary nerve block – A new approach using a computer-controlled anesthetic delivery system for maxillary sinus elevation procedure. A prospective study. Quintessence International, 2004;35:477-480.
49. CRA Newsletter. Products reported most by CRA evaluators. Products CRA evaluators "Can't Live Without". July 2004.;28(7):2-4.
50. Palm AM, Kirkegaard U, Poulsen S. The Wand versus Traditional Injection for Mandibular Nerve Block in Children and Adolescents: Perceived Pain and Time of Onset. Pediatric Dentistry, 2004;26:481-484.

51. Shepherd PA, Eleaszer PD, Clark SJ, Scheetz JP. Measurement of Intraosseous Pressures Generated by the Wand™, High-Pressure Periodontal Ligament Syringe, and the Stabident System. *J. Endodontics*, 2001;27(6):381-384.
52. Ashkenazi M, Blumer S, Eli I. Effective of Computerized Delivery of Intrasulcular Anesthetic in Primary Molars. *JADA*, 2005;136:1418-1425.
53. Ghelber O, Gebhard R, Adebayo G, Szmuk P, Hagberg C, Ianucci D.:Utilization of the Compuflo™ in determining the pressure of the epidural space: a pilot study. *Anesth Analg* 2005;100:S-189.
54. Ghelber O, Gebhard R, Szmuk P, Hagberg C, Ianucci D.: Identification of the epidural space-a pilot study of a new technique. *Anesth Analg* 2005;100:S-255
55. Gebhard R, Ghelber O, Szmuk P, Pivalizza E, Walters D: Pressure Monitoring During Injection of Local Anesthetics for Nerve Blocks Utilizing the Compuflo® Injection Pump. *Anesth Analg* 2005
56. Kudo M. Initial Injection Pressure for Dental Local Anesthesia: Effects on Pain and Anxiety. *Anesthesia Progress*, 2005; 52:95-101.
57. Versloot J, Veerkamp JSJ, Hoogstraten J. Computerized anesthesia delivery system vs. traditional syringe: comparing pain and pain-related behavior in children. *Eur J Oral Sci.* 2005;113:488-493.
58. Öztas N. Ulusu T. Bodur H. Dogan C. The Wand in pulp therapy : An alternative to inferior alveolar nerve block. *Quint. International.* 2005;36:(7)559-564.
59. Ram D. Kasssiner J. Assessment of a palatal approach-anterior superior alveolar (P-ASA) nerve block with the Wand® in paediatric dental patients. *J Clin Pediatr Dent.* 2006;16:348-3551.
60. Jalevik B, Klingberg G, and G. KLINGBERG, Sensation of Pain when using Computerized Injection Technique, the Wand™. *IADR Pan European Federation* Sept. 13-16, 2006.
61. Hochman MN, Friedman MF, Williams WP, Hochman CB. Interstitial Pressure Associated with Dental Injections: A Clinical Study. *Quintessence International*, 2006;37:469-476.

***Unpublished Manuscript Reviewed.***

62. Michaelian MJ, Agha-razi F, Hutter J. Anesthetic efficacy of the periodontal ligament injection using the Wand vs. the intra-osseous injection using stabident. (Unpublished manuscript, BU Dental)

63. Franco L, Naseri L, Hochman MN, Camarda AJ. A New Multi- Cartridge Injection Technique for Achieving Safe and Effective Dental Local Anesthesia. Submitted for publication, Oct. 2003.

**Textbooks:**

Barnard D. Hazards of Local Anesthesia Injections. ISBN: 0-620-26308-3. Pretoria, South Africa. (pg2) 1998.

Murphy D. Ergonomics and the Dental Care Worker. ISBN: 0-87553-0233-0. Washington DC, American Public Health Association. (pg 181) 1998.

Wilkins E. Clinical Practice of the Dental Hygienist 8<sup>th</sup> Ed. ISBN: 0-683-30362-7. Philadelphia, Pennsylvania. (pg 503) 1999.

Dionne R, Phero J, Becker D. Management of Pain and Anxiety in the Dental Office. ISBN: 0-7216-7278-7. Philadelphia, Pennsylvania. (pg 204-06) 2002.

Malamed S. Handbook of Local Anesthesia 5<sup>th</sup> Ed. ISBN:0-323-02449-1. Elsevier/Mosby, St. Louis, Missouri. 2004.



Milestone Scientific  
220 S. Orange Ave.  
Livingston, NJ USA 07039  
[www.milesci.com](http://www.milesci.com)  
Toll-Free: 800-862-1125  
973-535-2717  
Fax: 973-535-2829

STA6513-260  
Printed in USA